

TR333 - TP Environmental

Front view



TR333 - TP Environmental

Rear view



Age groups appropriate for:

 Toddlers & Pre-Schoolers

 Primary to Big Kids

 Teenagers to Young Adults

 Whole family / Young at Heart

TR333 - TP Environmental

Plan view

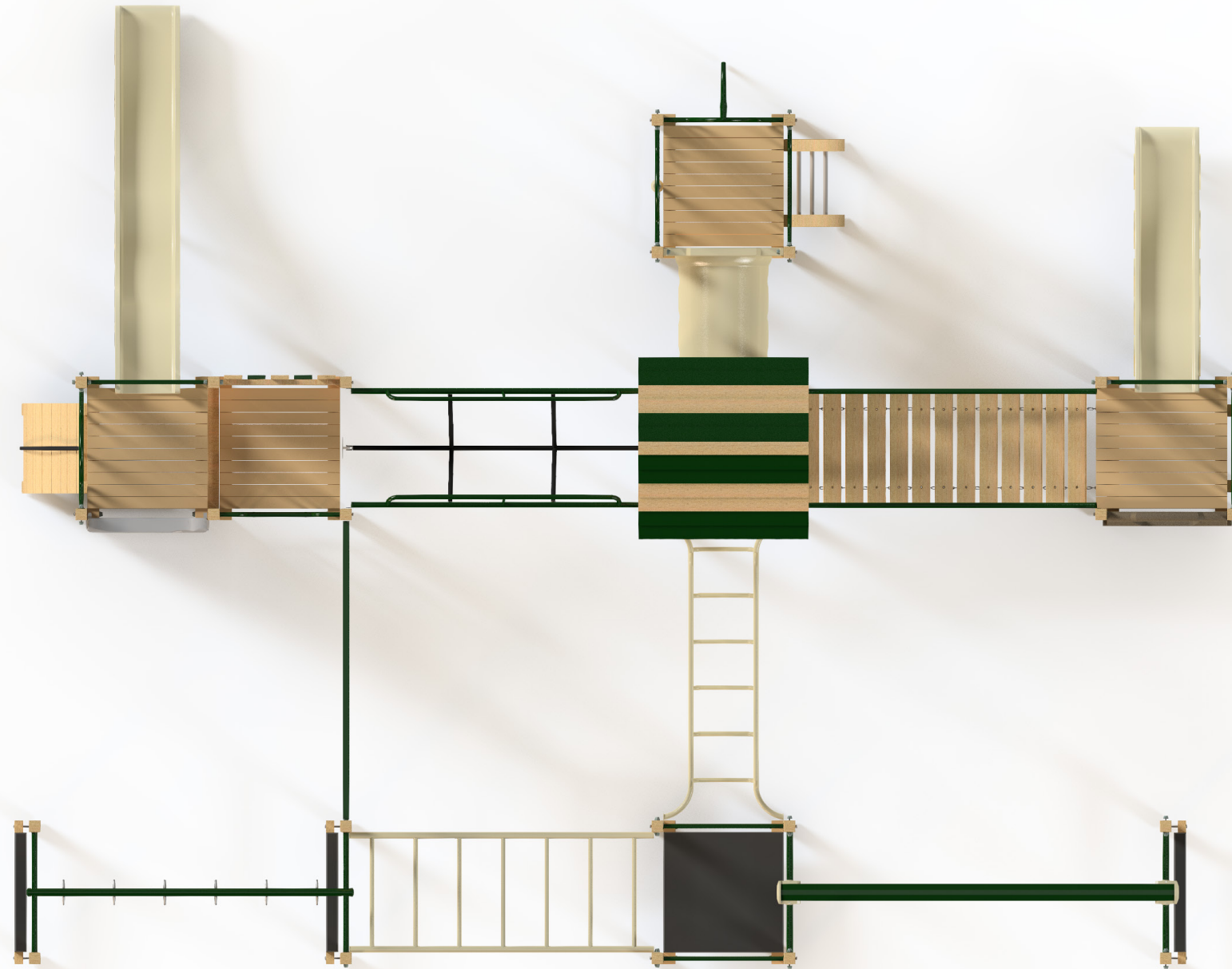

Age groups appropriate for:

 Toddlers & Pre-Schoolers

 Primary to Big Kids

 Teenagers to Young Adults

 Whole family / Young at Heart

1:100 @ A3

Fallzones

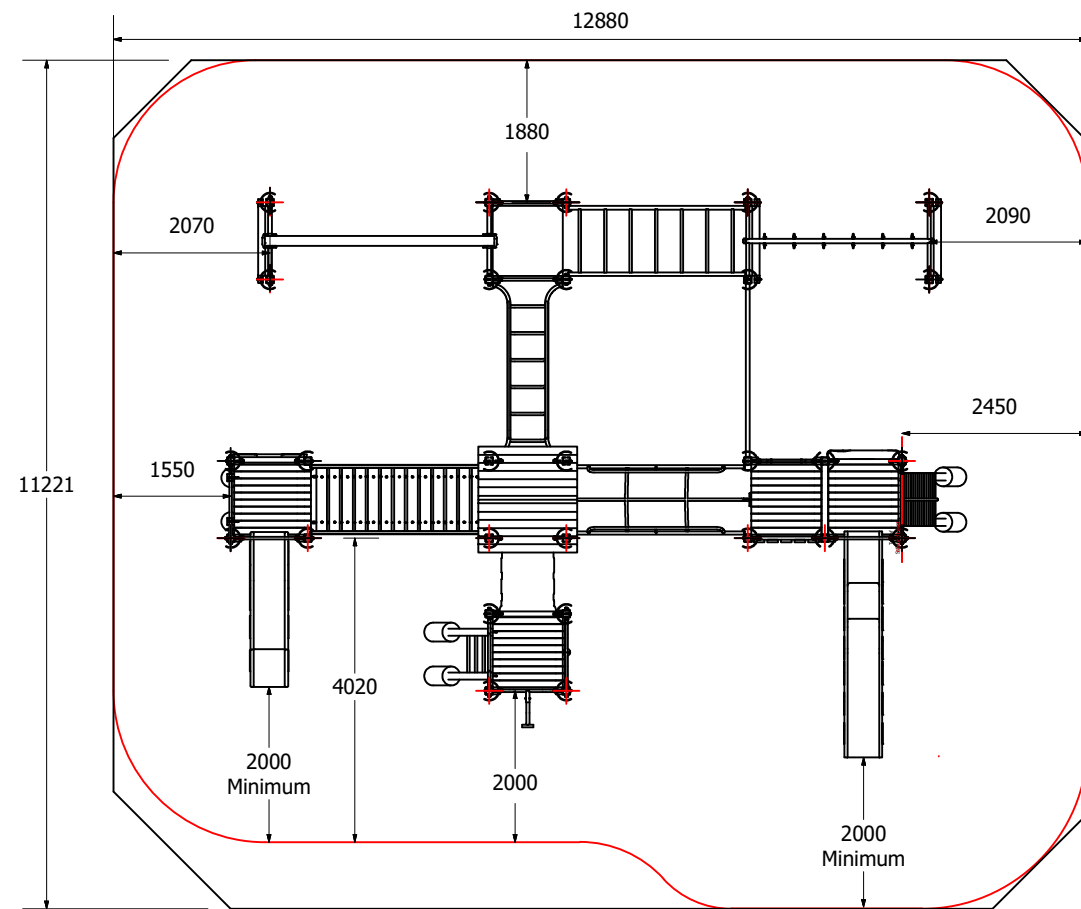

Front Elevation

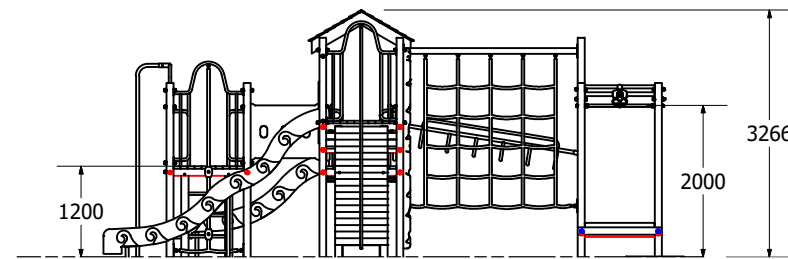

Right Elevation

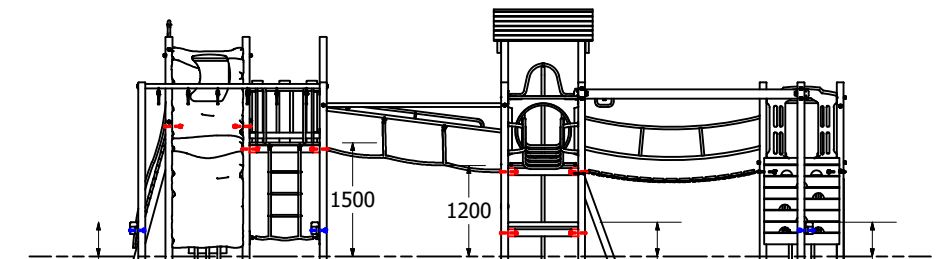

Technical Information	
Main Dimension	12880 x 11221
Total Area	142 m2
Max FHO	2030
Heaviest Part	70 kg
Compliant to	NZS 5828:2015 AS 4685:2017 EN 1176:2008

REVISION HISTORY			
REV	DESCRIPTION	DATE	BY
0	Creation	28/09/2017	