



2024-2025

ROPE PLAY EQUIPMENT

CATALOGUE NO. 28



Adventure made in Germany
30
YEARS
HUCK PLAY EQUIPMENT

Discover our new
**COLOUR
COMBINATIONS!**

ENGLISH
VERSION

HUCK 
PLAY EQUIPMENT

www.huck.net



Contents

- 19** Rope play equipment for children from the age of 2
- 29** Rope play equipment for children from the age of 3
- 75** Rope play equipment for children from the age of 6
- 115** Parcours
- 125** Climbing nets and bridges
- 141** Swings
- 165** Rope net pyramids
- 187** Trampolines and bouncer
- 203** Playground accessories
- 225** References

Our Bird's Nest Tower
„Black Forest“ page 107 or
on site at the visitor center
Grube Fortuna in
Central Hesse.





Dear Readers,

Once again this year it is our pleasure to present you the new Huck rope play equipment catalogue number 28.

You already know us as a forward-thinking company. This applies not only to our products, but of course also to our value-based corporate philosophy. The topic of sustainability plays a major role here. For this reason, we have also decided this year to have our popular catalogue printed on certified recycled paper. But that's not all - the print shop also works according to Climate Partner's climate protection concept. A decision made out of conviction and for the future of our children. We are also thinking ahead when it comes to innovations.

This year, the inclusive idea is incorporated even more than usual into our new developments. With "Sombbrero", for example, we have created a variant of the traditional bird's nest that places a special focus on inclusive participation. On pages 8 - 9 we will introduce you to 2 more new devices from this area: the inclusion ramp swing and the inclusion mat.

But our bird's nest has also received an update that is something to be proud of. New 2-colour rope wraps and different link colours make it an eye-catcher on any playground. Both products can be found on page 5.

Pages 10 - 11 also give you a wonderful overview of the different colours of our proven Hercules rope.

The classification by age group as well as cross-age chapters can also be found in this catalogue. What is different is the increased elaboration of our sustainable corporate philosophy on pages 12 - 13 as well as the inclusion topic on page 4.

With number 28 you will find a contemporary catalogue that once again reflects our values and way of working.

We hope you enjoy it: Let yourself be inspired.

VALENTIN HUCK

STEFAN HUCK

WOLFGANG KEINER

HUCK Seiltechnik GmbH
Management



Print product with financial
climate contribution
ClimatePartner.com/53323-2311-1017



Innovative and inclusive play worlds:

Experience the fascination of modern playground equipment in our latest collection



Where better to promote inclusion than when children play together? Children don't judge. Children accept other children as they are. Children make the world a better place for all of us with their way of living inclusion.

That's why we see it as our duty to create a place for our children to come together, play, live and be free. Together. For each other. With our rope play equipment, which has been developed with an inclusive mind, we can do just that.



New two-tone combination of our rope wrapping!
With all our bird's nests.

Our new coloured link mat!
Now it's getting colourful.

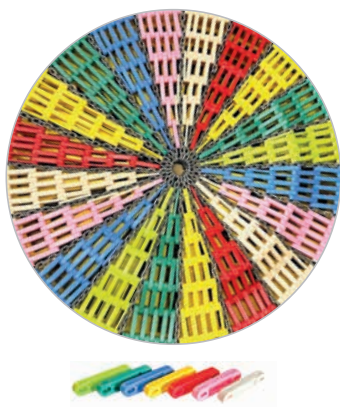

Higher, further, faster. Mentally free – ready to take off. Everything is possible with our rope play equipment. We offer our children unlimited opportunities to play and the freedom to test themselves without having to prove themselves. Recognising boundaries, overcoming one's own limits – surpassing oneself. Children learn through play. And they learn best together. We at Huck Play create all the possibilities for you. And we have been doing this for over 30 years.



Original HUCK Bird's Nest Sombrero

Art. No. 4649-140 / Art. No. 4649-120



Our bird's nest to lean on!
Gives children support and security.

Valentin Huck

© lichtwerk | christian plaum



For symbol explanation see
folding card at the back

Suspension height: 2.00 m – 2.50 m



ca. Ø 1.20 or 1.40 m



1.30 m – 1.55 m



Minimum distance
to swing frame: 0.80 m

Suspension ropes:

green, rust-orange, blue, yellow,
black, beige, grey, red, orange-
fluorescent, turquoise, fuchsia

Link mat:

neon green, dark green, blue,
yellow, red, pink, beige, black
(single or in combination)

Rope wrapping:

blue, green, red, beige, black
(single or in combination)



Discover our new two-tone
combination of rope
wrapping & our coloured
link mat!



Mikaado 1000

Art. No. 4597-11

Mikaado 2000



Art. No. 4597-12

© lichtwerk | christian plaum









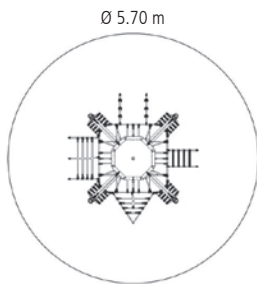

For symbol explanation see folding card at the back

Art. No. 4597-11

-  2.20 m
-  Ø 3.10 m
-  25.6 m²
-  Ø 5.70 m
-  1.90 m
-  1.4 m³
-  12
- 



Art. No. 4597-12

-  2.20 m
-  3.60 x 1.85 m
-  23.5 m²
-  5.70 x 4.95 m
-  1.90 m
-  1.3 m³
-  12
- 

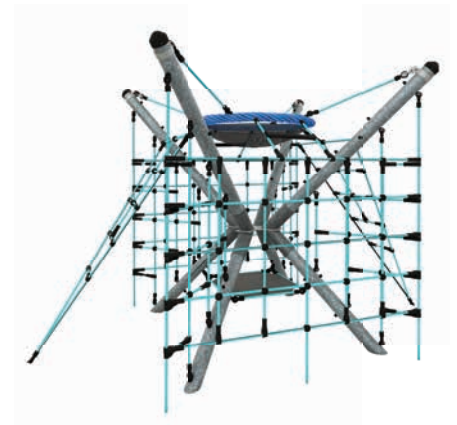
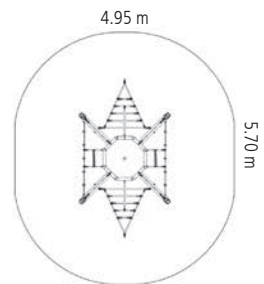

Please note!
The space required for foundations (assembly space) is bigger than the minimum space requirement for the equipment.



Swing Frame Orlando





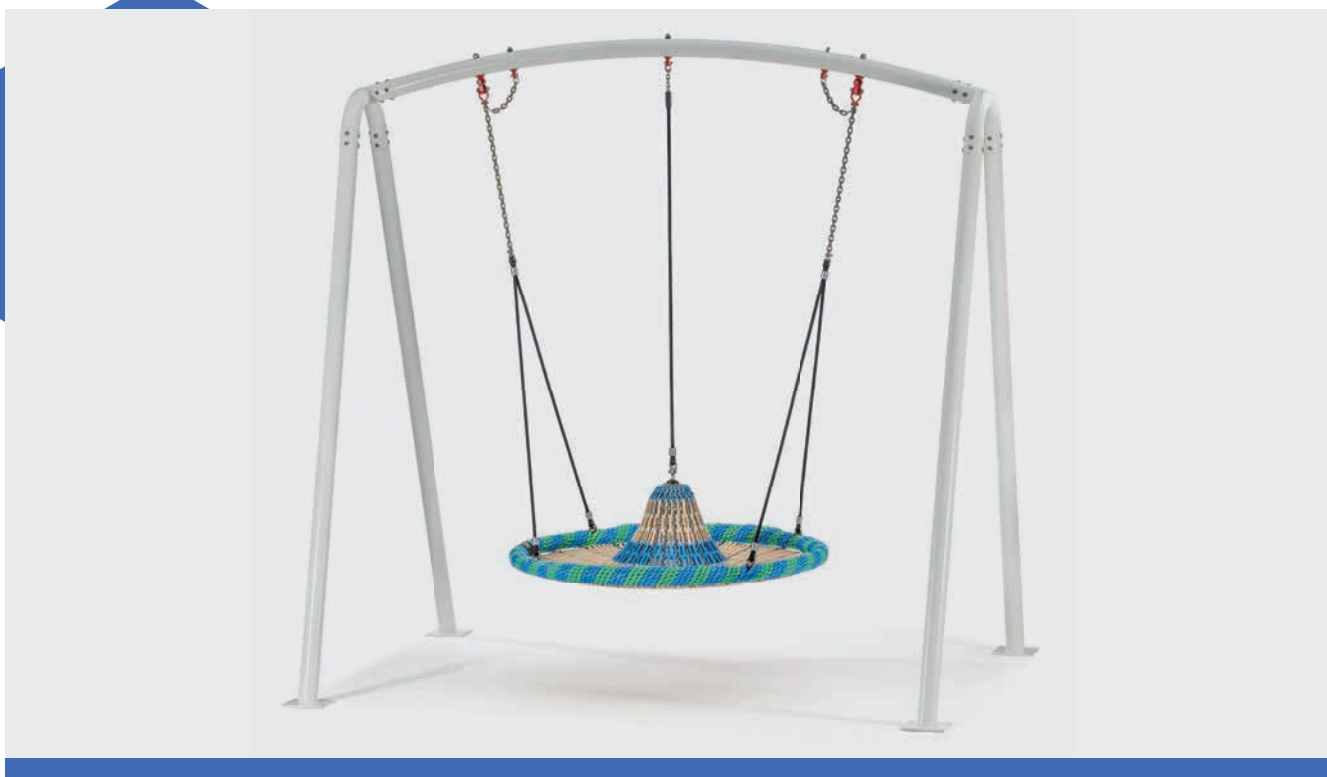

Art. No. 4576-1-220

© lichtwerk | christian plaum



For symbol explanation see folding card at the back

Suspension height: 2.20 m

-  2.47 m
-  3.50 x 1.70 m
-  18 m²
-  7.30 x 2.45 m
-  1.40 m
-  0.9 m³
- 

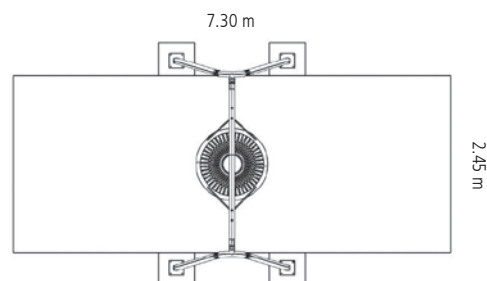



Rope Recliner (Inclusive)

Art. No. 4774-08

© Siegersbusch 2023



For symbol explanation see folding card at the back

For people with disabilities, as our swing promotes the positive development of motor skills!



Suspension height: 2.00 m – 2.50 m



ca. 0.54 x 1.20 m



1.30 – 2.50 m



Minimum lateral distance to the frame: 0.65 m

Suspension ropes:
green, rust-orange, blue, yellow,
black, beige, grey, red,
orange-fluorescent,
turquoise, fuchsia

Lying surface: beige



Extra wide 54cm lying surface
made of pp ropes



Inclusive Track

Art. No. 4655-1-2



Accessibility wherever you want.
Move independently on sand, grass and
different surfaces.



Dimensions: width max. 2 m, length individual, different shapes possible

Fastening: Ground anchoring (chain pieces) can be flexibly placed

Colour link mat: neon green, dark green, blue, yellow, red, pink, beige, black

Surface: lawn, sand, for all fall protection surfaces

Also available in colour!

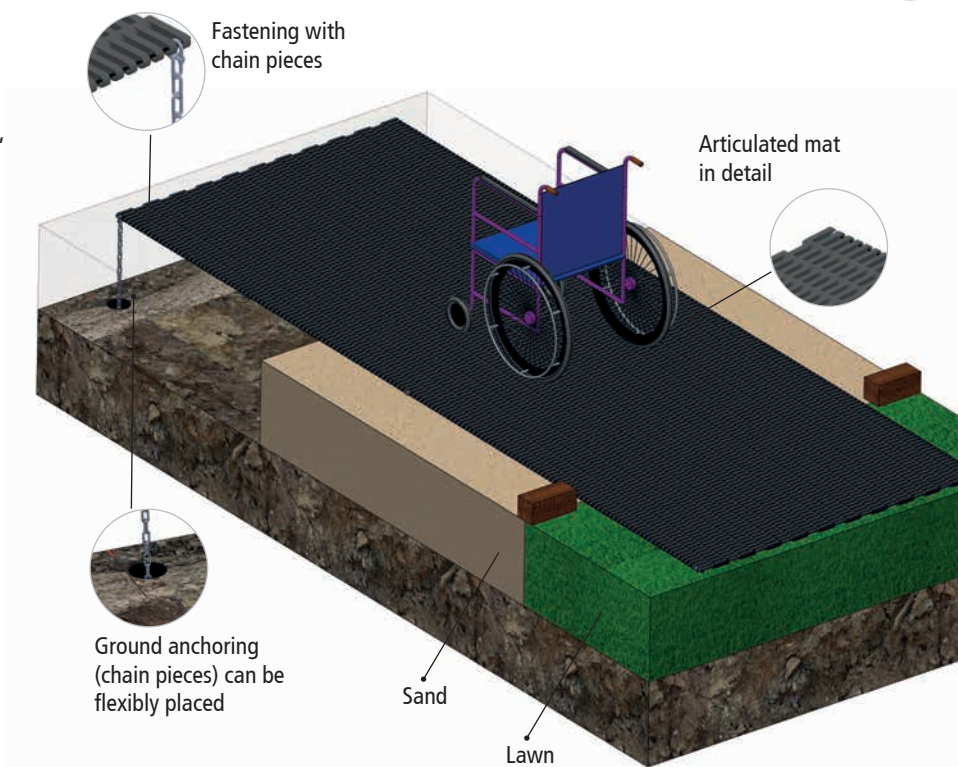

Advantages

- ⊕ easy to install
- ⊕ easy to clean
- ⊕ very robust and stable
- ⊕ coloured link mat





OUR HERCULES ROPE

Quality made in Germany



Construction and features

For our Hercules cordage, six steel strands sheathed with polyester yarn are twisted into a rope. A firm connection between the steel and the polyester sheath is achieved by braiding and simultaneously bonding between the yarn and the steel strand. Our Hercules cordages are manufactured with a nominal diameter of 16 mm and 18 mm, the single strand has a diameter of 5 mm and 6 mm respectively. In addition, we also offer Hercules ropes with steel core or Hercules ropes in flame retardant.

Compared to other plastics, polyester already has a high color, UV and abrasion resistance. However, in order to meet the demands and loads of playground equipment, all ropes are additionally equipped with a surface impregnation during production for greater resistance.

Basically, the topic of abrasion is always a topic to be considered by all rope manufacturers, which can never be completely ruled out. Depending on the stress, a Herculean rope will never last forever. Some of our ropes have been in continuous use on playgrounds around the world for more than 20 years. However, we are constantly taking measures to improve and optimize the quality of our Hercules ropes. To simulate the abrasion on our ropes, a specially developed test bench was set up. A stainless steel abrasive is moved back and forth over the clamped rope (so-called double strokes) until the steel of the strands can be seen. The measured double strokes represent a comparable quality feature for our rope construction.

Safety is a top priority for all our products.

MAXIMUM EFFICIENCY IN PLANNING AND IMPLEMENTATION:

The entire production, from the production of fibres to the production of ropes and the manufacture of the playground equipment, is in our hands.

Production of all ropes in Germany



NEW TWO-TONE COMBINATION OF OUR WRAPPING ROPE!

Get creative with us and create your individual colour concept for free!





GREEN

01

Ø 16 mm or
Ø 18 mm



RUST

03

Ø 16 mm



ORANGE-FLUORESCENT

03F

Ø 16 mm
Suitable for indoor use



BLUE

04

Ø 16 mm or
Ø 18 mm



YELLOW

05

Ø 16 mm or
Ø 18 mm



BLACK

06

Ø 16 mm or
Ø 18 mm



RED

07

Ø 16 mm or
Ø 18 mm



HEMP

08

Ø 16 mm or
Ø 18 mm



TURQUOISE

11

Ø 16 mm



GREY

66

Ø 16 mm



PINK

71

Ø 16 mm

The HUCK
Hercules quality:

- ⊕ Each rope consists of six steel strands coated with polyester
- ⊕ Quality assurance through several test methods
- ⊕ High colour, UV and abrasion resistance
- ⊕ Made in Germany

OUR COMMITMENT TO SUSTAINABILITY

For the well-being of our children and conservation of resources

Our high-quality rope connectors have a long service life. Shaped without sharp corners and edges, they ensure particularly comfortable playing. Thanks to the forward-looking design, on-site replacement is just as possible as individual rope sections.



TIP:

Combine coloured ropes with our colourful plastic connectors and the new coloured link mat and get your dream playground equipment!

Connections



PLASTIC ROPE CONNECTOR

Available in blue, yellow, red, beige, black for Ø 16 mm Hercules rope



PLASTIC KNOT BALL

Available in blue, yellow, red, beige, black for Ø 16 mm Hercules rope



PLASTIC T-PIECE

Available in blue, yellow, red, beige, black for Ø 16 mm Hercules rope



We always keep safety and durability in mind for all our playground equipment.

Used worldwide for decades, our plastic connectors connect a wide variety of ropes and nets.



Sustainability for the future of our children

Energy-optimized manufacturing processes through more than 750kwp photovoltaics – all our buildings are modernized in terms of energy efficiency.

Reduction of the CO₂ balance through the use of heat recovery.

Reduction of waste by feeding it back into the production process (yarn residues) and continuous research to reduce production waste.

Our rope play equipment is an expression of our commitment to sustainability. With them, we not only offer fun and adventure, but also set an example for the preservation of our environment.

A handwritten signature in black ink, which appears to read "Stefan Huck".



THE HUCK POST SOLUTION

Strong posts, custom design:

Secure play equipment according to your preferences!



Douglas fir

Round-milled, sanded, glazed and with true premium quality as well as a 10-year warranty (taking into account our maintenance specifications): This core-free and low-crack wood is supplied with hot-dip galvanized and pre-assembled post shoes. We give a 5-year warranty for cross beams and head beams.

Cracking (core separated)
Our Douglas fir woods are core cut. This means that each trunk is sawn lengthwise into 4 parts and then peeled round. This significantly reduces the tension between the outer and heartwood and thus the formation of cracks. In the event of cracking, the stability of the device does not decrease and TÜV tests confirm that children do not get caught on it.

Due to its natural properties, the wood can darken over time. During storage and assembly, it should be noted that reaction discoloration occurs due to contact with moisture and ferrous metals. However, as part of our maintenance work, this has no effect on the durability and quality.



Robinia

Robinia posts made of robinia give our HUCK playground equipment a particularly original look. The only European wood with resistance class 1 is approved for earth shoring without chemical wood preservatives. We give you a 5-year warranty on the robinia posts – because our guaranteed sapwood-free design of the posts is an additional quality feature. These timbers are also provided with 2 safety steel tabs for added safety.



Steel

The HUCK steel posts are made of high-quality, hot-dip galvanized steel and are therefore extremely stable and corrosion-resistant. Due to the natural silver effect of the hot-dip galvanizing, the colourful rope elements come into their own perfectly. If you wish, you can also easily spice up the silver steel colour on site with high-quality special paint or have a powder coating carried out by us in all common RAL shades.

Your advantages:

- ⊕ Durable and easy to clean
- ⊕ Insensitive during transport, storage and assembly
- ⊕ Scratch-resistant surface (silver-coloured glossy)
- ⊕ Silver tone goes well with numerous mesh colours from the range
- ⊕ can be painted with separately available special paint
- ⊕ powder-coated in all common RAL shades

Planners and operators can tailor many of our playground equipment and courses to the respective requirements and wishes. Talk to us about it!

HUCKAluPlus

Our rope play equipment with aluminium connectors

Almost all of our most popular rope play equipment is also available in the so-called "AluPlus version" on request.

Aluminium connections

All relevant rope and net connections are made of robust cast aluminium. This material is lightweight yet durable and strong, requires virtually no maintenance and is ideal for long-term use in all weather conditions. Rounded shapes of the parts ensure comfortable playing, romping and relaxing.

The nets are made of six-strand Hercules rope with a diameter of 18 mm – adapted to the aluminium connectors. Through the use of these materials, the devices receive an additional update to the versions with plastic connectors and Hercules ropes in 16 mm diameter, which have been known and popular for decades.

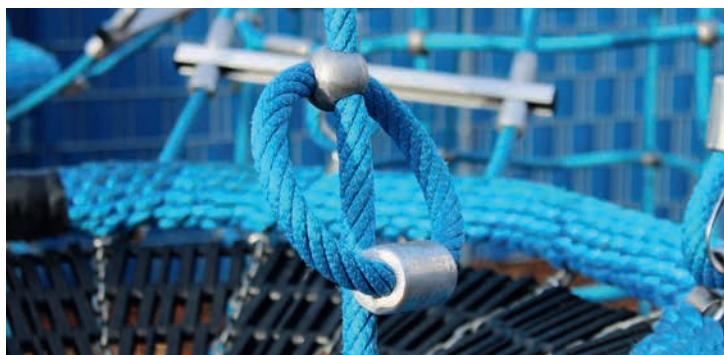
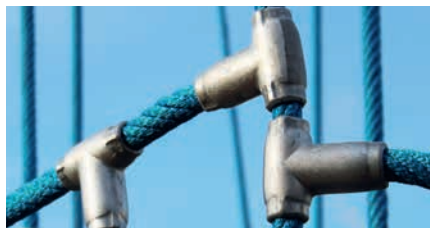

Contact us and let us make you an offer for your rope play equipment in the HUCK AluPlus version.

Art. No. 4652-10AP
Bird's Nest tower "Midi"
– AluPlus-Version



**ALUPLUS
ROPE CONNECTOR**

Available for
Ø 18 mm Hercules rope



**ALUPLUS
KNOT BALL**

Available for
Ø 18 mm Hercules rope



**ALUPLUS
T-PIECE**

Available for
Ø 18 mm Hercules rope

OUR QUALITY PROMISE

Our Commitment to Safety

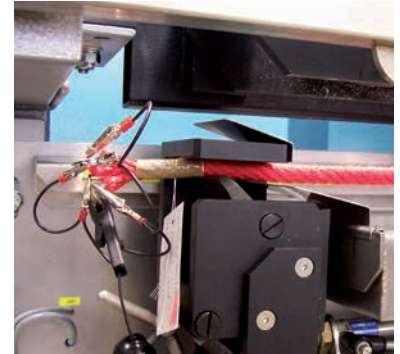

Withstand high stresses

All our ropes and connectors are constantly tested in terms of breaking forces and pull-out values. In our own test laboratory, we find out what payload determination bolted connections have and what pull-out values work for pressed connections.

UV resistance

To ensure long-lasting quality, we test components for their UV resistance. This allows us to simulate the behavior of the materials in real outdoor use with UV light. Do they become brittle? Do they lose safety-relevant properties? Are the colors fading?

Abrasion Resistance & Dimensional Stability

This method is used to check material fatigue and abrasion. What load cycle numbers do we have for connections of e.g. Bounce? How does the material react to variable, dynamic loads? The processes run according to the specification of variable movements or deformations.

TÜV-tested HUCK Quality

For many years, we have been working hand in hand with the TÜV SÜD testing institute in order to comply with current requirements and standards and to improve our products beyond that. The certificates available to us confirm the execution according to the current playground equipment standard and can be made available at any time on request.

For more information and the table on subsoil and drop heights, see on the right.

IPEMA Certification

We are a member of the International Play Equipment Manufacturers Association. In the interest of public safety, IPEMA offers a product certification program for public playground equipment and surface materials. The Program validates a participant's products according to one or more of the standards mentioned herein. The certification is carried out by TÜV SÜD America in accordance with the current ASTM 1487 (similar to the European playground equipment standard DIN EN 1176).



TÜV-tested for the safety of our children

DIN EN 1176 regulates the safety requirements and test methods for playground equipment, which are developed by the Technical Committee of the European Committee for Standardization (CEN/TC 136) "Sports, playground and other leisure equipment" and are now valid in 33 CEN member states (European Committee for Standardization). As a full-fledged member, we are always up to date and can take upcoming changes/renewals etc. into account in our product development at any time. We take compliance with the standards and the associated responsibility very seriously in order to protect users from dangers when using the playground equipment properly and sensibly.

At the same time, these standards regulate the requirements for the surface under the playground equipment and the monthly, quarterly or annual inspection and maintenance of the playground equipment. This necessary information is included in every combined installation and maintenance manual and will help you comply with regulations.



In the table below you can see the approved floor materials (fall protection material), which are permissible depending on the height of the play equipment. For Germany, there is a so-called A-deviation, which regulates the use of turf as a soil material up to a fall height of 1.50 m, which is only permitted in the other European area up to a fall height of 1.00 m!



The quality control in the production of our ropes ensures the highest safety standards for safe playgrounds.

Subsurface and Drop Height

Ground material	Description	Minimum layer thickness in mm *incl 100 mm wear & tear effect	Max. height of fall mm
Grass / Topsoil	Europe-wide		≤ 1000
Grass / Topsoil	Germany		≤ 1500
Bark mulch	20-80 mm particle size	300	≤ 2000
		400	≤ 3000
Woodchip	5-30 mm particle size	300	≤ 2000
		400	≤ 3000
Sand or gravel	0.25-8 mm grain size	300	≤ 2000
		400	≤ 3000
Other materials & layer thickness	Tested according to DIN EN 1177		As tested

Country-specific deviations must be observed.



**ENJOY
YOURSELF!**



ROPE PLAY EQUIPMENT

For children from the age of 2

HUCK play and climbing equipment on the following pages is especially suitable for pre-school settings, who look after children from the age of two.

They can run riot on different adventure bridges and courses and let their imagination run free. A multitude of climbing opportunities encourage the children to challenge and improve their abilities.

PRODUCT HIGHLIGHT

The innovative design of our playground equipment gives wheelchair users the opportunity not only to pass barrier-free, but also to actively participate in the game by experiencing the seesaw function – for an inclusive and collaborative play environment.

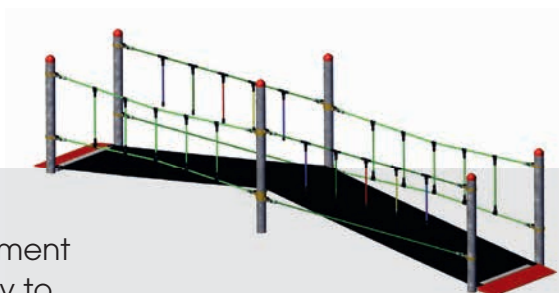

“Haiger” Inclusion Equipment
Page 21











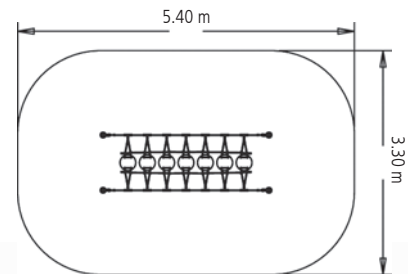

“Wobble Disc” Adventure Bridge

Art. No. 4959-60



For symbol explanation see folding card at the back



-  1.44 m
-  3.10 x 1.10 m
-  15.80 m²
-  5.40 x 3.30 m
-  0.45 m
-  1.75 m³
-  7
- 

Equipment
4 Steel posts (Ø 102 mm),
hot-dip galvanised,
length 2.40 m, with plastic cap

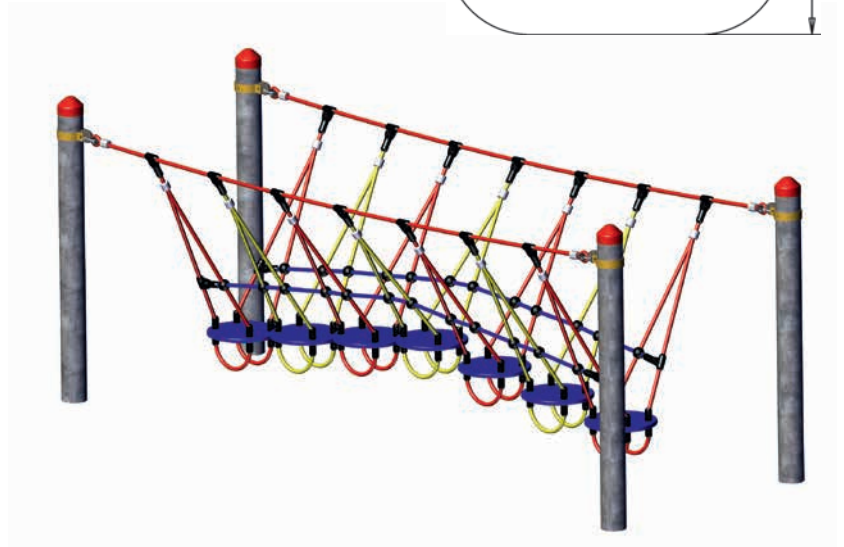









"Haiger" Inclusion Equipment

Art. No. 4591-90



For symbol explanation see folding card at the back

-  1.75 m
-  6.60 x 1.20 m
-  36.20 m²
-  9.10 x 4.20 m
-  0.35 m
-  1.40 m³
-  29
- 
- 

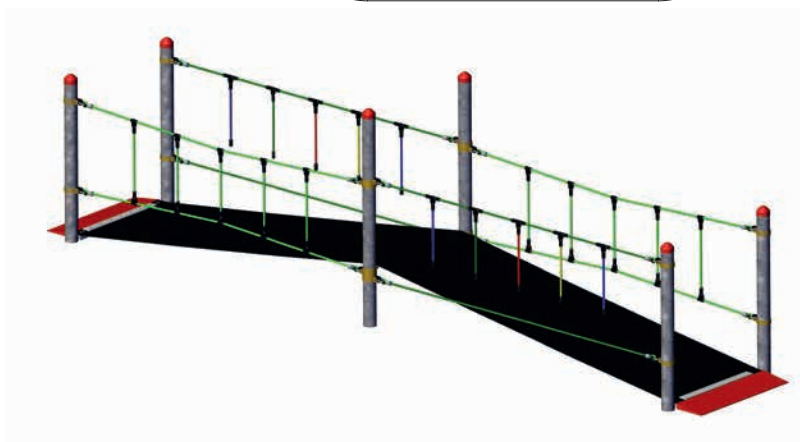
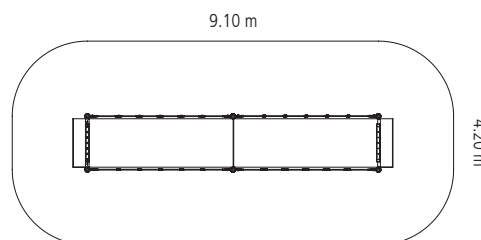

Equipment
 6 Steel posts (Ø 102 mm),
 hot-dip galvanised,
 length: 4 x 2.00 m, 2 x 2.40 m,
 with plastic cap











"Fortuna" Mini Pirate Tower

Art. No. 4687-35



For symbol explanation see folding card at the back

-  2.65 m
-  3.45 x 2.45 m
-  22.10 m²
-  5.90 x 5.10 m
-  1.45 m
-  1.00 m³
-  18
- 

Equipment
1 Steel posts (Ø 102 mm),
length 2.40 m,
4 steel cross posts,
hot-dip galvanised,
length 3.40 m,
with plastic cap

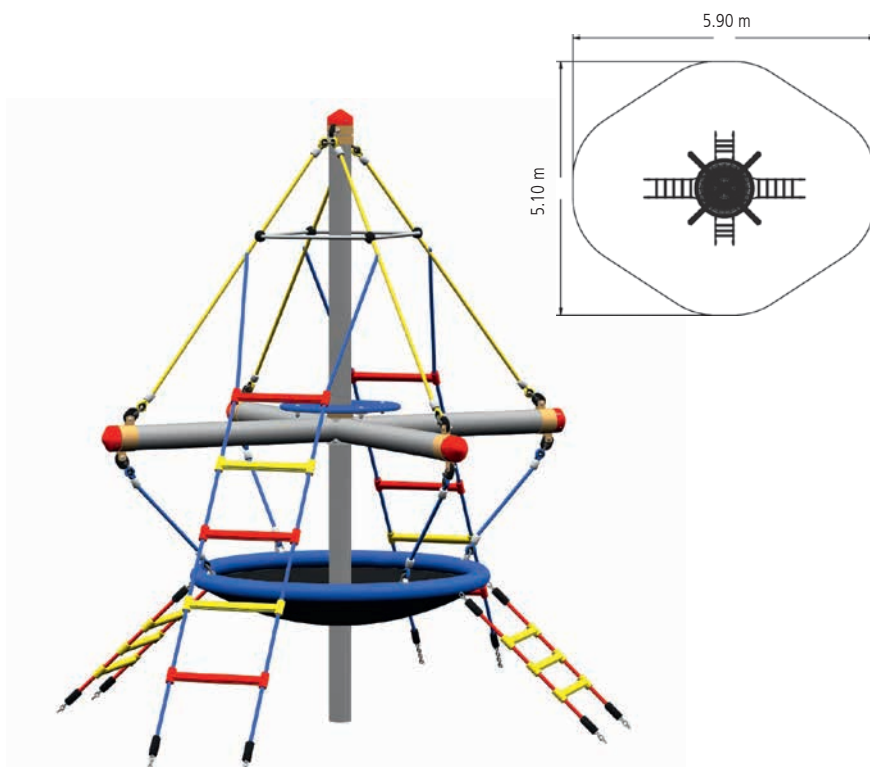

Sparrow's Nest with slide

Art. No. 4668-31, to dig in



For symbol explanation see folding card at the back

-  0.55 m (from top of slide rail: 1.10m)
-  1.65 x 2.90 m
-  18.44 m²
-  5.80 x 4.60 m
-  0.55 m
-  8
- 

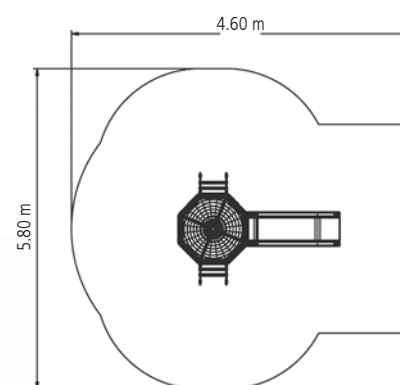









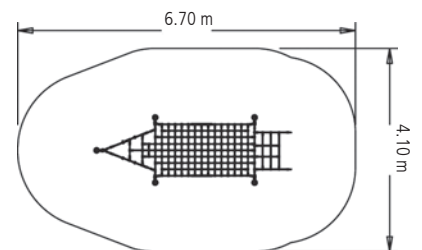

"Junior" Play Ship

Art. No. 4642-10



For symbol explanation see folding card at the back



-  1.44 m
-  4.20 x 1.40 m
-  23.10 m²
-  6.70 x 4.10 m
-  0.80 m
-  2.30 m³
-  12
- 

Equipment
5 Steel posts (Ø 102 mm),
hot-dip galvanised,
length 2.40 m,
with plastic cap

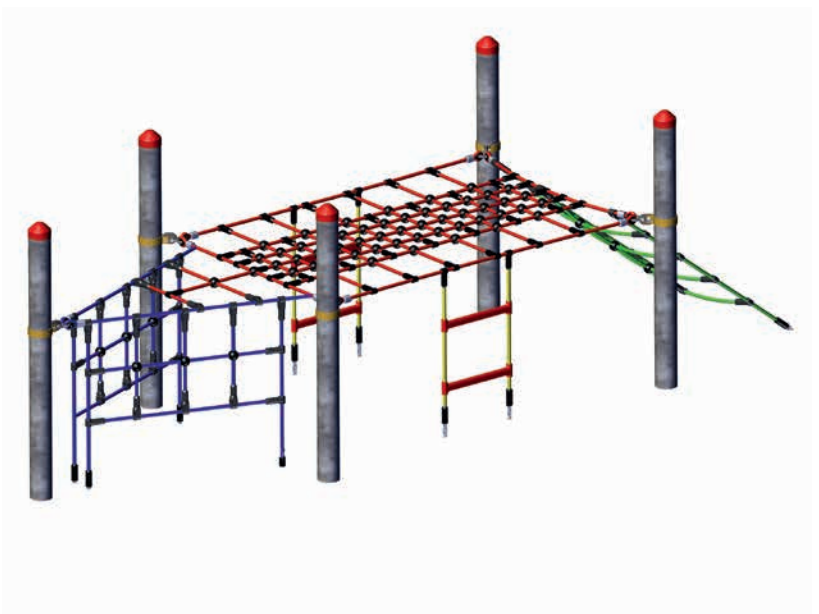









Mini Bird's Nest Tree

Art. No. 4652-30



For symbol explanation see folding card at the back

-  2.64 m
-  3.70 x 3.15 m
-  26.00 m²
-  6.25 x 5.70 m
-  0.80 m
-  0.75 m³
-  18
- 

Equipment

1 Steel posts (Ø 102 mm),
hot-dip galvanised,
length 3.60 m, with plastic cap
4 steel cross posts (Ø 102 mm),
hot-dip galvanised, with plastic cap

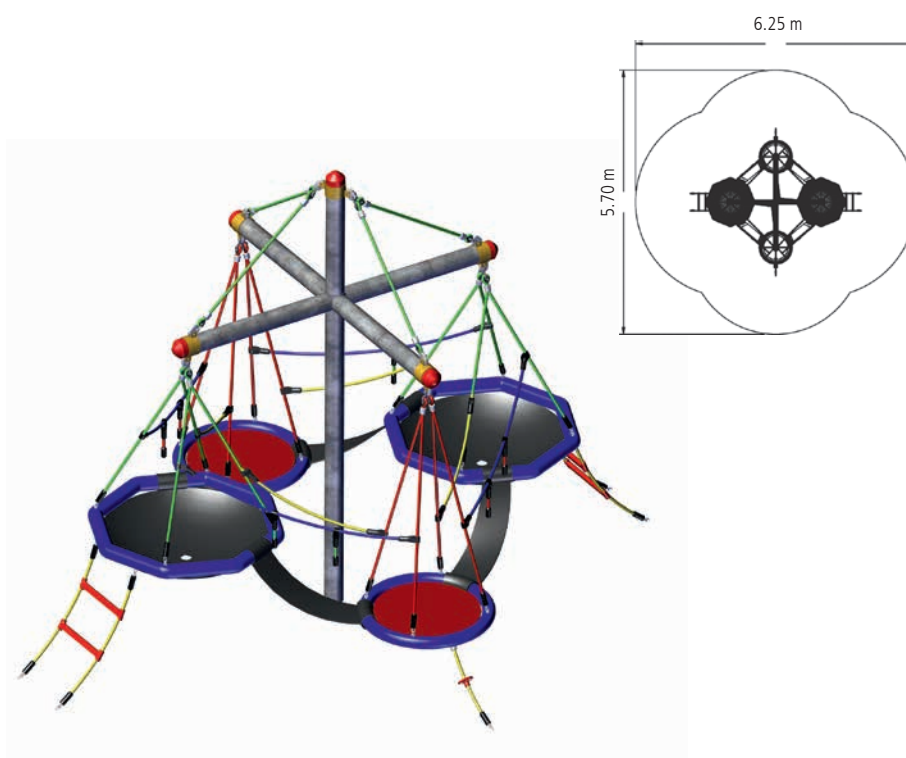



“Fortuna” Bird’s Nest Tower

Art. No. 4594-30



For symbol explanation see folding card at the back

 2.44 m

 Ø 2.70 m

 22.10 m²

 Ø 5.30 m

 1.00 m

 0.90 m³

 8



Equipment
1 Steel posts (Ø 102 mm),
hot-dip galvanised,
length 3.40 m,
with plastic cap

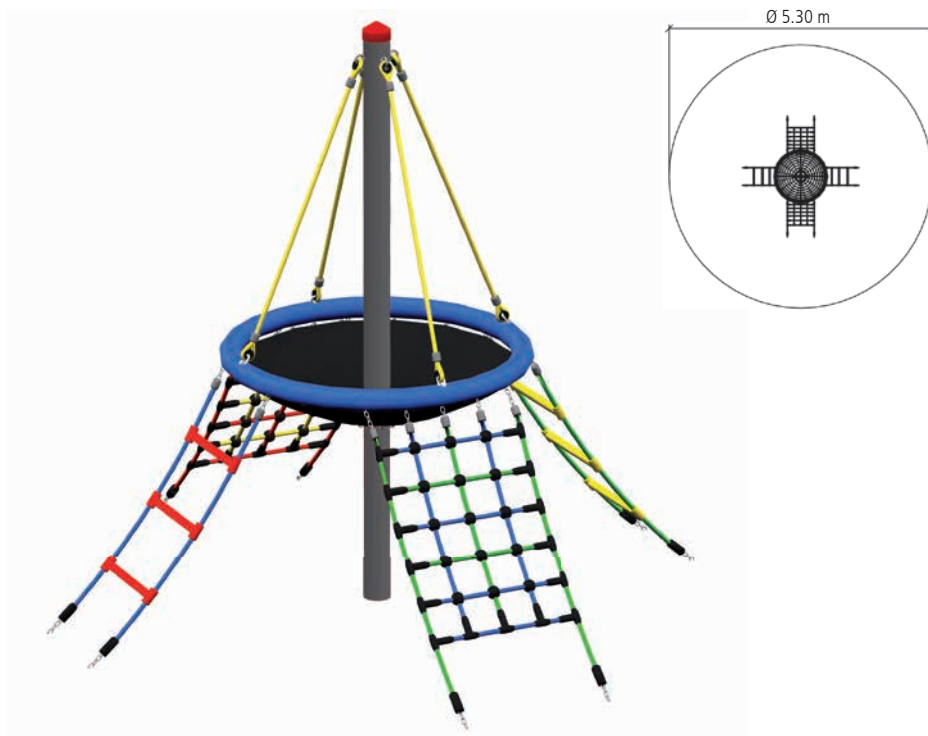







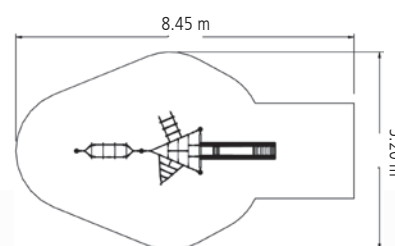

Witch's Slide & Net

Art. No. 4591-20



For symbol explanation see folding card at the back



-  1.80 m
-  5.50 x 2.00 m
-  30.40 m²
-  8.45 x 5.20 m
-  1.00 m
-  1.85 m³
-  7
- 

Equipment
4 Steel posts (Ø 102 mm),
hot-dip galvanised,
length 2.40 m,
with plastic cap

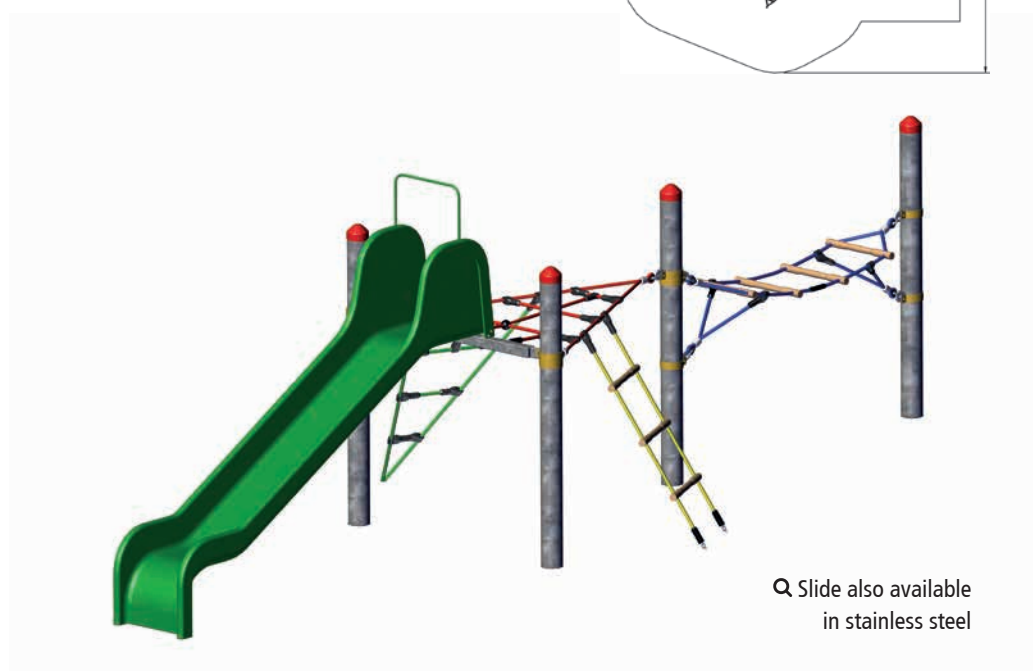

Q Slide also available
in stainless steel



FEEL SECURE



ROPE PLAY EQUIPMENT

For children from the age of 3

In the following pages you will find HUCK's play and climbing equipment, which are especially tailored to the needs of children from the age of 3. Children are challenged and stimulated through play on carousels, group swings and a multitude of obstacle courses, honing in on their motor skills and pushing fun in motion to the very top of the ladder – letting off steam, climbing, swinging, playing is the currency here.

PRODUCT HIGHLIGHT

Experience a unique play adventure with our outstanding climbing equipment, where up to 29 children can develop their motor skills in a variety of ways - a place full of joy, movement and communal experience.

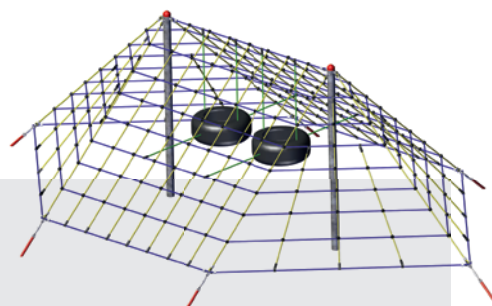

Tent Net
Page 73













Triple Course with slide

Art. No. 4591-66



For symbol explanation see folding card at the back

-  2.65 m
-  7.90 x 5.00 m
-  50.50 m²
-  10.90 x 7.80 m
-  1.00 m
-  1.60 m³
-  35
- 

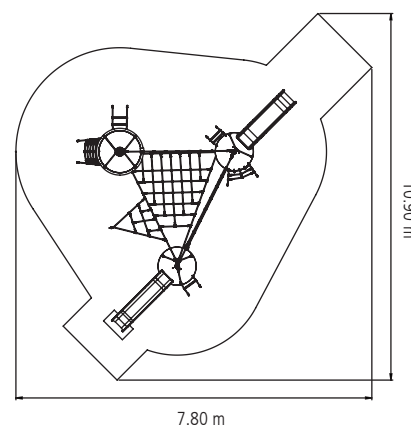

Equipment

- 1 Steel posts (Ø 102 mm), hot-dip galvanised, length 3.40 m
- 1 Steel posts (Ø 102 mm), hot-dip galvanised, length 3.00 m
- 1 Steel posts (Ø 102 mm), hot-dip galvanised, length 2.40 m

All posts with plastic cap







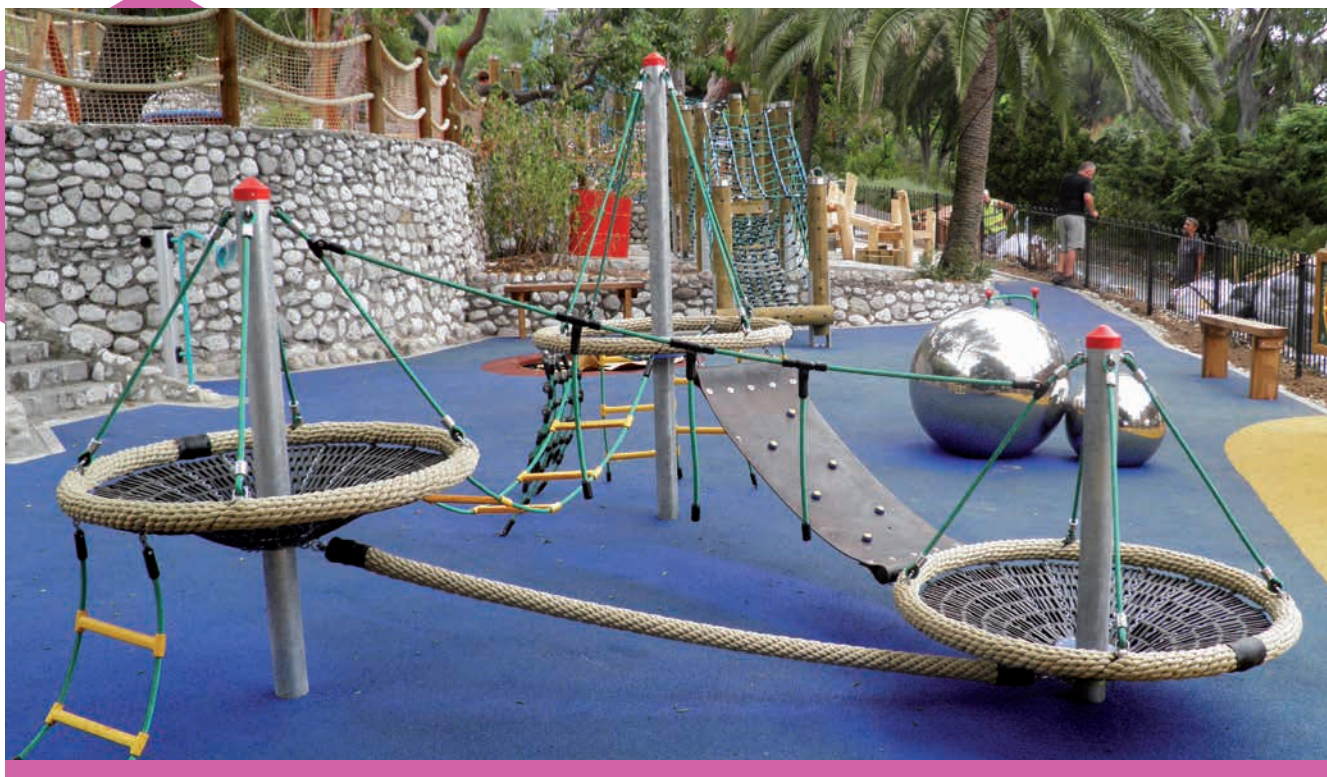



"Fortuna" Play Course

Art. No. 4591-65



For symbol explanation see folding card at the back

-  2.44 m
-  3.75 x 3.40 m
-  32.80 m²
-  6.75 x 6.40 m
-  1.00 m
-  2.00 m³
-  24
- 

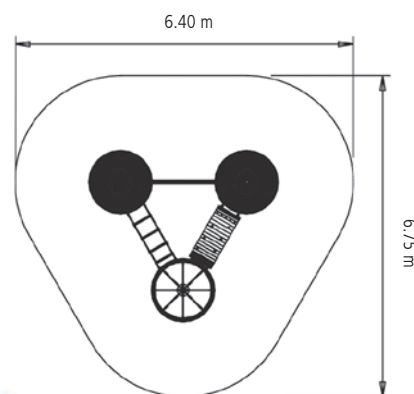

Equipment

- 1 Steel posts (Ø 102 mm), length 3.40 m, hot-dip galvanised
- 1 Steel posts (Ø 102 mm), length 3.00 m, hot-dip galvanised
- 1 Steel posts (Ø 102 mm), length 2.40 m, hot-dip galvanised

All posts with plastic cap











Maxi Hexagonal Climbing Castle

Art. No. 4587-21



For symbol explanation see folding card at the back

-  2.35 m
-  6.10 x 3.80 m
-  46.00 m²
-  8.30 x 7.50 m
-  2.30 m
-  1.10 m³
-  23
- 

6-sided construction with 6 Steel posts (Ø 102 mm), hot-dip galvanised, length 3.00 m, 6 steel cross posts each 1.50 m

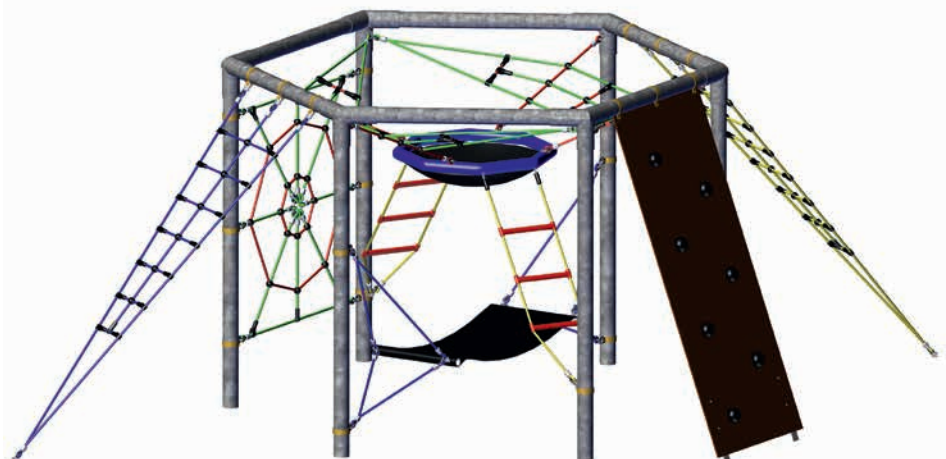
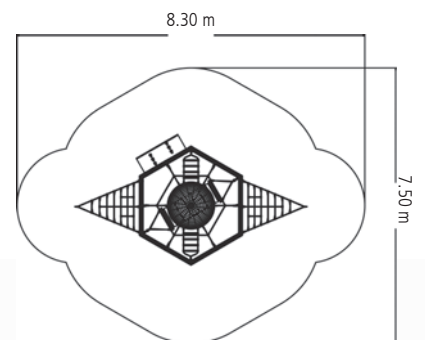









“Wooden Catwalk” Adventure Bridge

Art. No. 4959-20



For symbol explanation see folding card at the back

-  1.44 m
-  3.10 x 1.10 m
-  17.00 m²
-  5.60 x 3.40 m
-  0.60 m
-  1.80 m³
-  9
- 

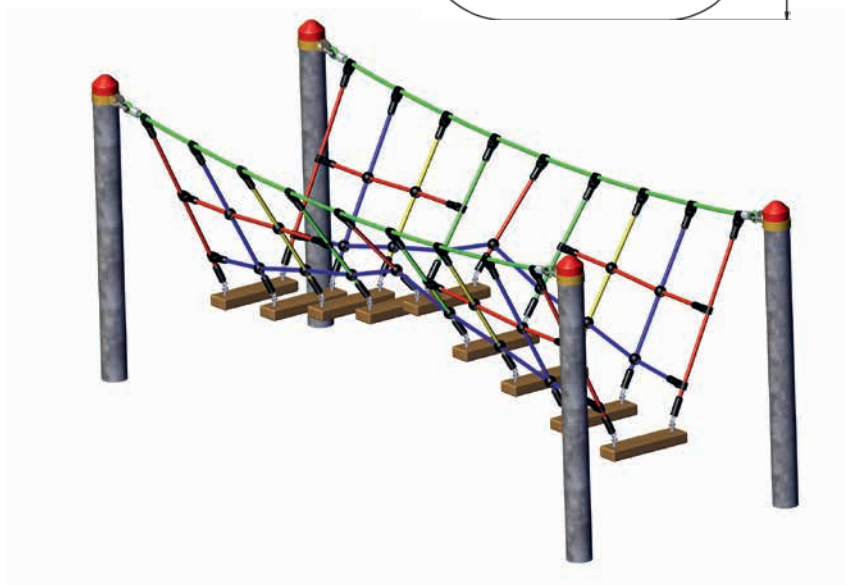
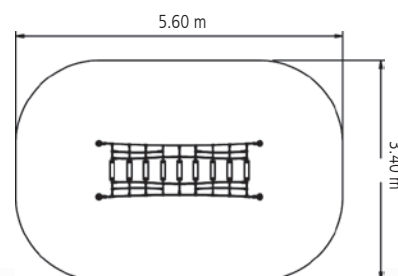

Equipment
 4 Steel posts (Ø 102 mm),
 hot-dip galvanised, length 2.40 m,
 with plastic cap











"Wobble Rung" Adventure Bridge

Art. No. 4959-50



For symbol explanation see folding card at the back

-  1.44 m
-  3.10 x 1.10 m
-  15.70 m²
-  5.20 x 3.40 m
-  0.35 m
-  1.80 m³
-  7
- 

Equipment
4 Steel posts (Ø 102 mm),
hot-dip galvanised, length 2.40 m,
with plastic cap

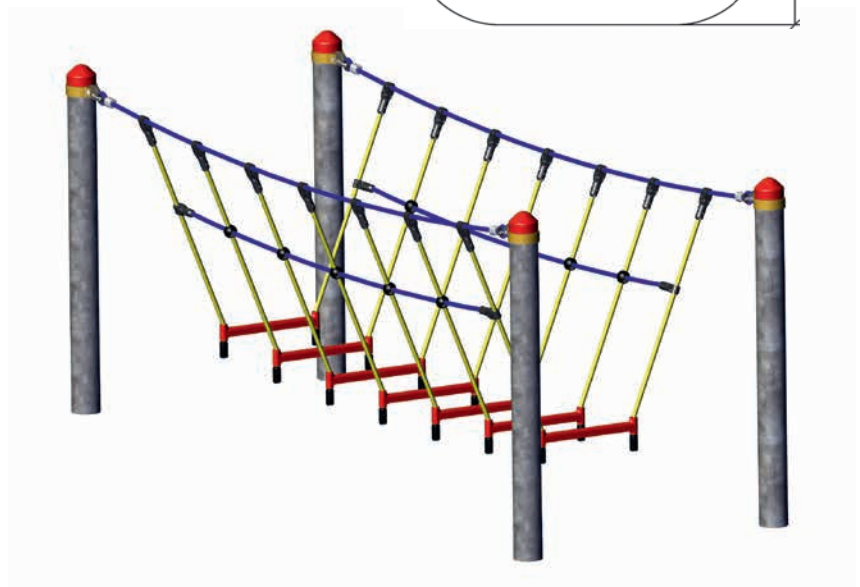
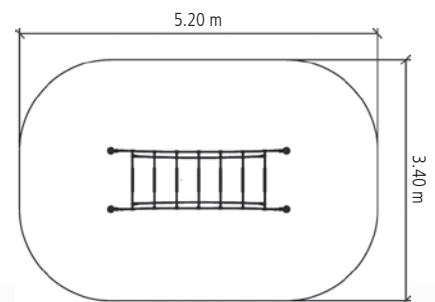









Mini Rope-End Swinger

Art. No. 4585-45



For symbol explanation see folding card at the back

-  1.45 m
-  3.10 x 1.10 m
-  13.6 m²
-  4.90 x 3.20 m
-  0.60 m
-  1.75 m³
-  4
- 

Equipment
 4 Steel posts (Ø 102 mm),
 hot-dip galvanised, length 2.40 m,
 with plastic cap

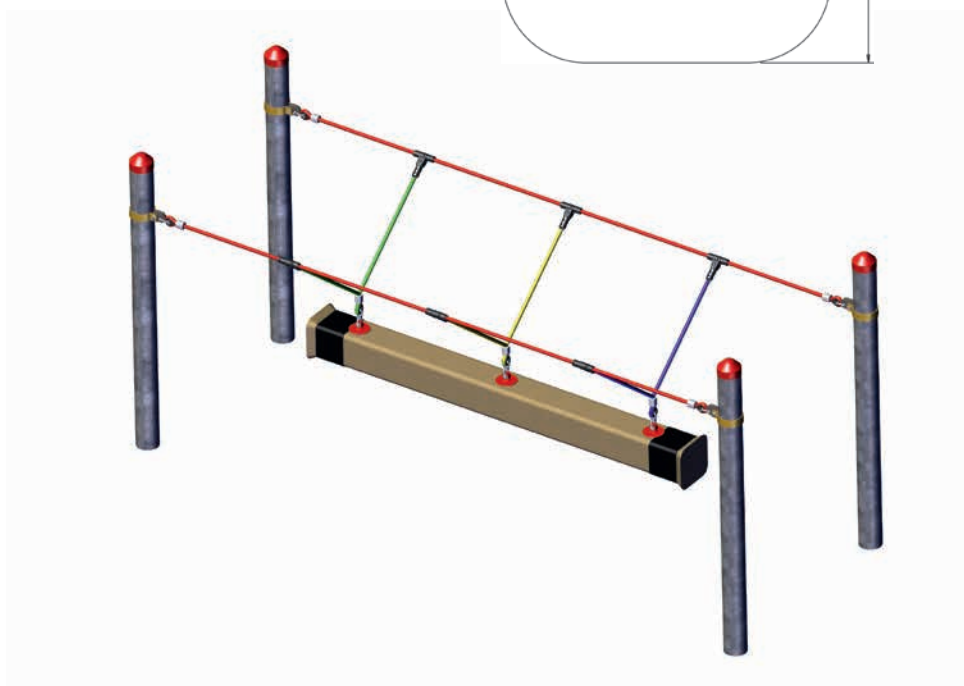
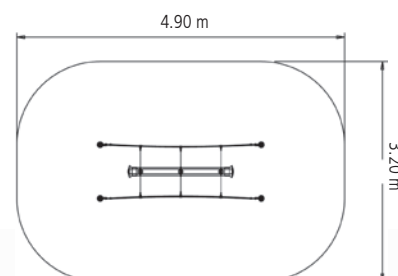











Adventure Honeycomb Nest

Art. No. 4959-70



For symbol explanation see folding card at the back

-  1.44 m
-  4.50 x 1.10 m
-  25.50 m²
-  6.90 x 4.00 m
-  1.20 m
-  1.90 m³
-  9
- 

Equipment
4 Steel posts (Ø 102 mm),
hot-dip galvanised, length 2.40 m,
with plastic cap

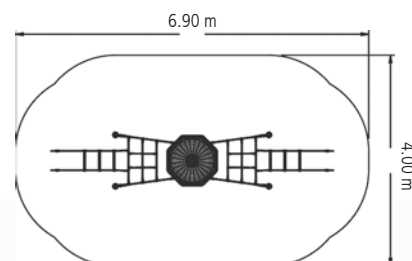









Swinging Honeycomb Nest

Art. No. 4959-71



For symbol explanation see folding card at the back

-  1.44 m
-  3.10 x 1.10 m
-  12.70 m²
-  Ø 4.05 m
-  0.50 m
-  1.50 m³
-  3
- 
- 

Equipment
 4 Steel posts (Ø 102 mm),
 hot-dip galvanised, length 2.40 m,
 with plastic cap

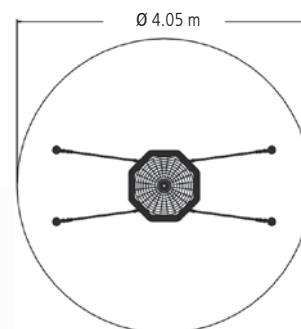











Original HUCK Bird's Nest on springs

Art. No. 4670 for dig-in ground anchor



For symbol explanation see folding card at the back

-  0.80 m
-  Ø 1.25 m
-  8.30 m²
-  Ø 3.75 m
-  0.80 m
-  4
- 
- 
- 

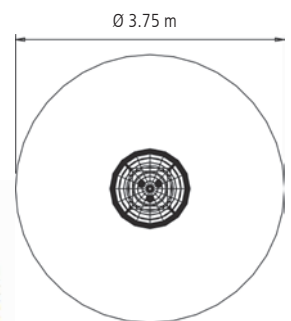









Little Eagle's Nest Carousel

Art. No. 4668-20 for dig-in ground anchor



For symbol explanation see folding card at the back

-  0.45 m
-  Ø 1.05 m
-  19.60 m²
-  Ø 5.00 m
-  0.45 m
-  3
- 
- 

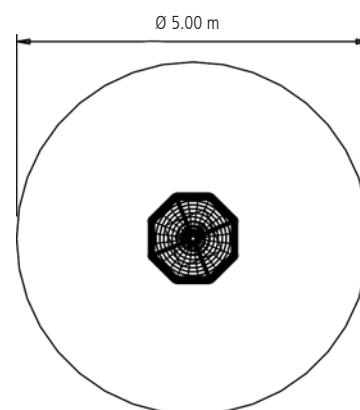



Little Eagle's Nest

Art. No. 4634S with slide (GRP)

Art. No. 4634-1S without slide



Q Slide also available in stainless steel, other colours on request.

For symbol explanation see folding card at the back

Without slide

	1.00 m
	2.75 x 2.10 m
	17.30 m ³
	5.05 x 4.70 m
	1.00 m
	0.70 m ³
	7

With slide

	1.70 m
	3.80 x 2.80 m
	23.50 m ³
	6.40 x 5.10 m
	1.00 m
	0.90 m ³
	8

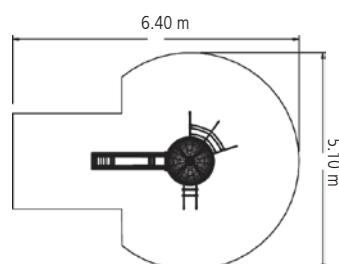
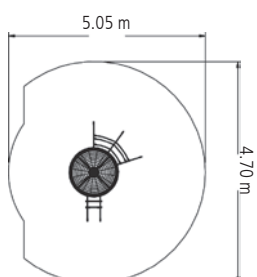









Tarantula

Art. No. 4597-10



For symbol explanation see folding card at the back

-  1.85 m
-  4.10 x 2.90 m
-  28.00 m²
-  6.30 m x 5.30 m
-  1.46 m
-  5.20 m³
-  11
- 

Equipment
6 Steel posts (Ø 102 mm),
hot-dip galvanised, length 3.20 m,
with plastic cap

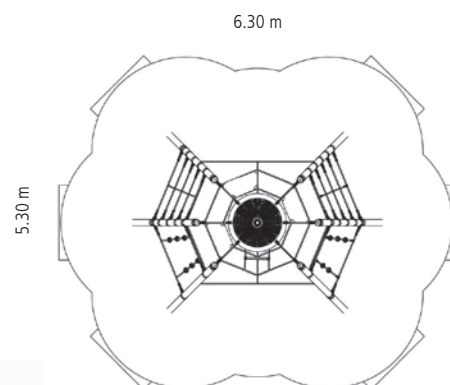

Please note!
The space required for foundations (assembly space) is bigger than the minimum space requirement for the equipment.











Easy-Climb 1

Art. No. 4591-40-1



For symbol explanation see folding card at the back

-  2.44 m
-  2.35 x 2.35 m
-  24.8 m²
-  5.30 x 5.30 m
-  2.05 m
-  1.55 m³
-  10
- 

Equipment
4 Steel posts (Ø 102 mm),
hot-dip galvanised, length 3.40 m,
with plastic cap

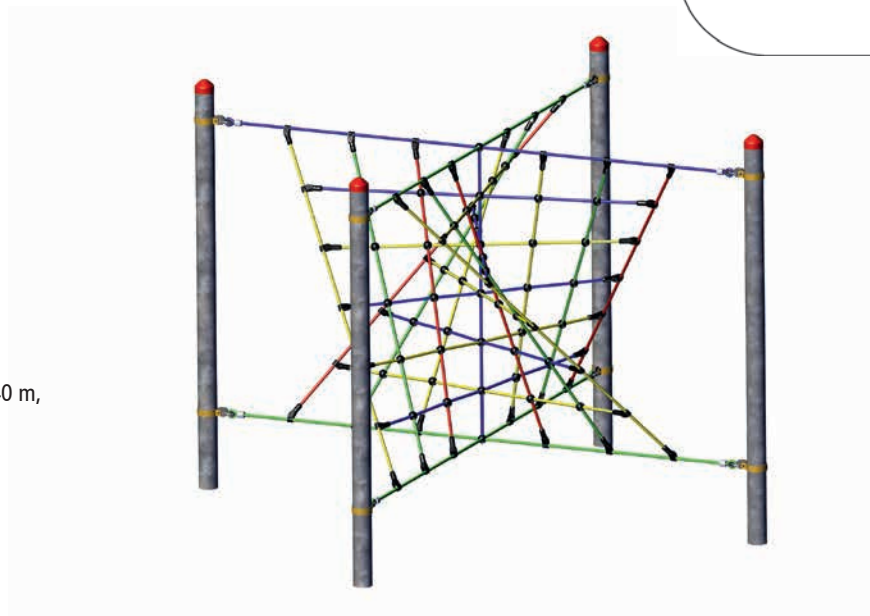
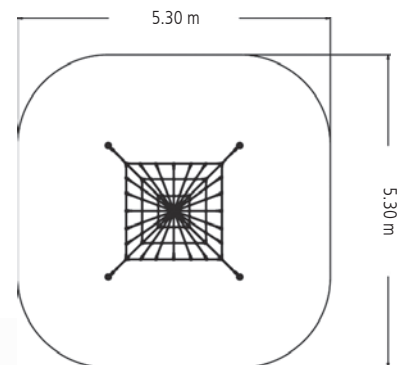









Easy-Climb 4

Art. No. 4591-40-4



For symbol explanation see folding card at the back

-  2.04 m
-  2.35 x 2.20 m
-  18.70 m²
-  4.60 x 4.50 m
-  1.50 m
-  1.25 m³
-  6
- 

Equipment
2 Steel posts (Ø 102 mm),
hot-dip galvanised, length 3.00 m,
with plastic cap

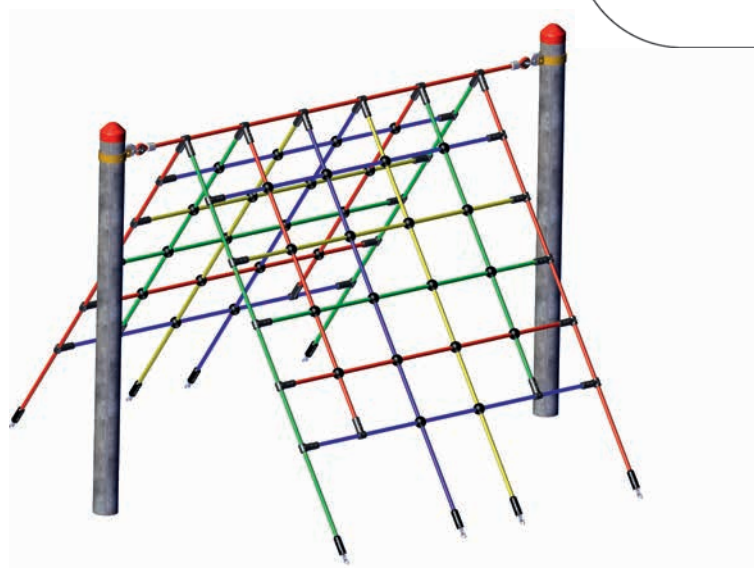
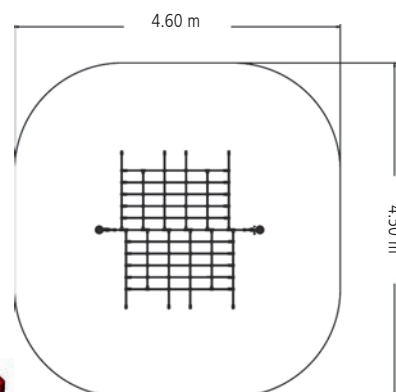











Mini-M Slide

Art. No. 4540-20



For symbol explanation see folding card at the back

-  1.75 m
-  3.30 x 2.20 m
-  20.00 m²
-  5.90 x 4.70 m
-  1.00 m
-  1.25 m³
-  4
- 

Equipment
2 Steel posts (Ø 102 mm),
hot-dip galvanised, length 2.40 m,
with plastic cap

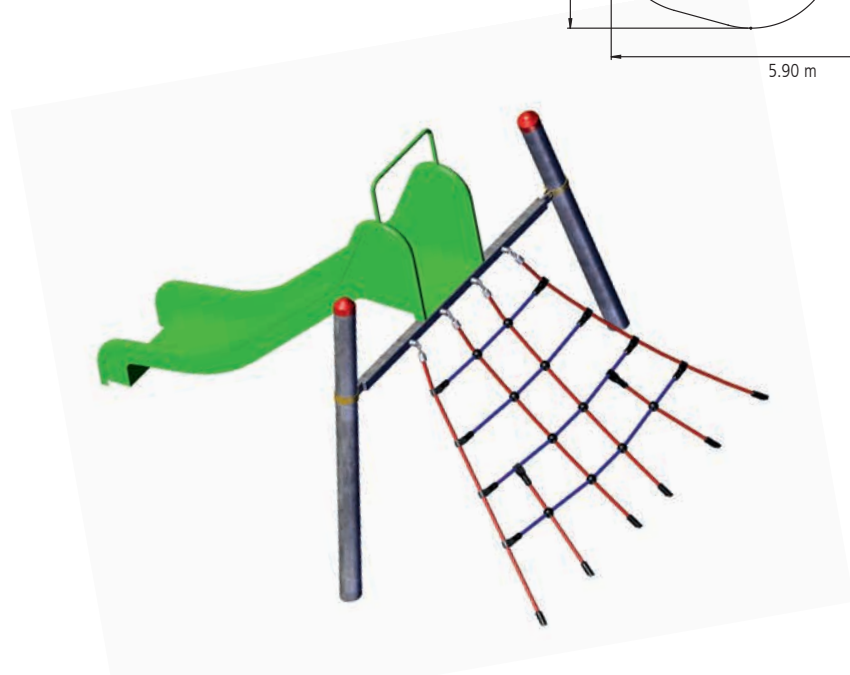
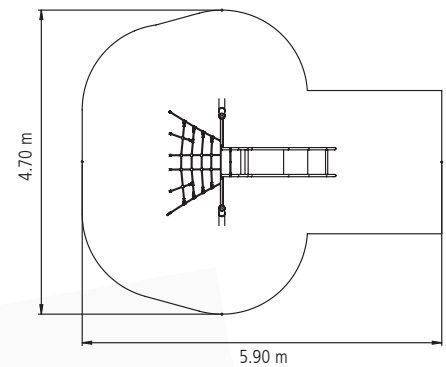

Climbing Equipment "Colour mix"

Art. No. 4960-500, Powder-coated steel posts (Colour tone as required)

Art. No. 4960-500F, Hot dip galvanized steel



For symbol explanation see folding card at the back

- 3.55 m
- 3.45 x 3.15 m
- 29.00 m²
- 6.70 x 6.05 m
- 1.00 m
- 2.10 m³
- 11
-

Post Lengths
 Art. No. 4960-500 and Art. No. 4960-500F
 2 posts, each 4.50 m
 2 posts, each 4.00 m
 2 posts, each 2.50 m

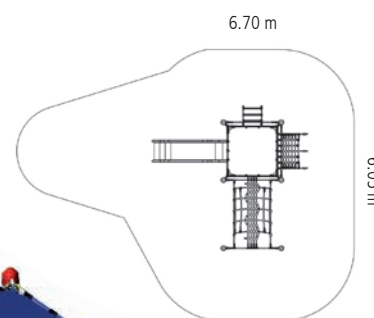

Art. No. 4960-500
 6 Steel posts (Ø 102 mm), hot-dip galvanized and powder coated (colour as requested), with plastic cap

Art. No. 4960-500F
 6 Steel posts (Ø 102 mm), hot-dip galvanized, with plastic cap









Climbing Bench

Art. No. 4800



For symbol explanation see folding card at the back

-  1.80 m
-  4.15 x 1.95 m
-  26.70 m²
-  7.15 x 4.80 m
-  1.00 m
-  21
- 

Equipment
Steel frame, hot-dip galvanised,
with plastic cap,
Seating made of plastic planks

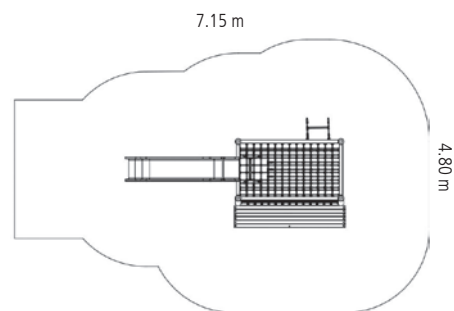

Play Cube with slide

Art. No. 4635



For symbol explanation see folding card at the back

- 1.80 m
- 3.40 x 3.15 m
- 28.00 m²
- 6.85 x 5.70 m
- 1.00 m
- 1.10 m³
- 13
-

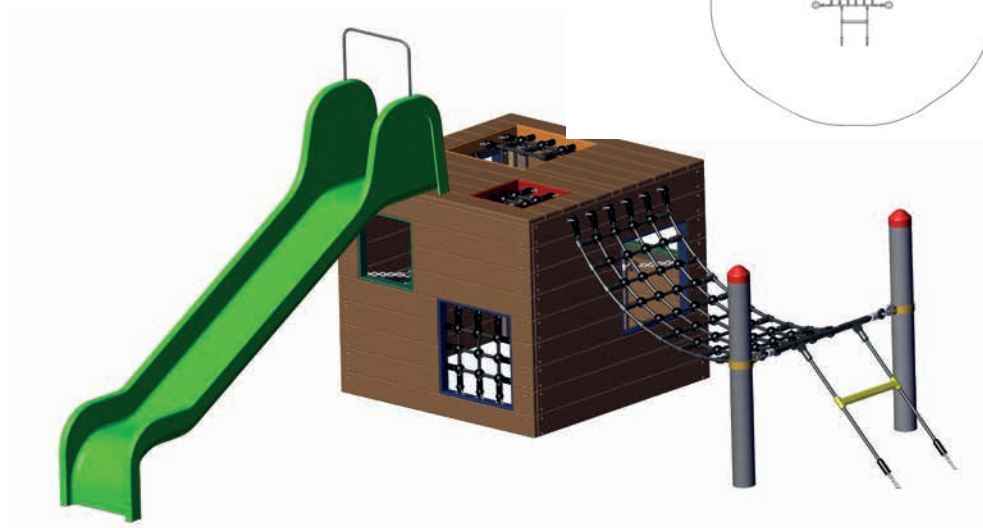
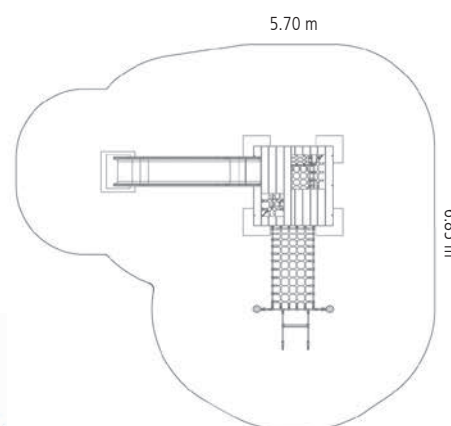

Equipment
 Cube made from robinia wood,
 2 Steel posts, hot-dip galvanised,
 length 2.00 m, with plastic cap



Lantern Climbing Nest

Art. No. 4530-20



Lantern Swing Nest

Art. No. 4530-50

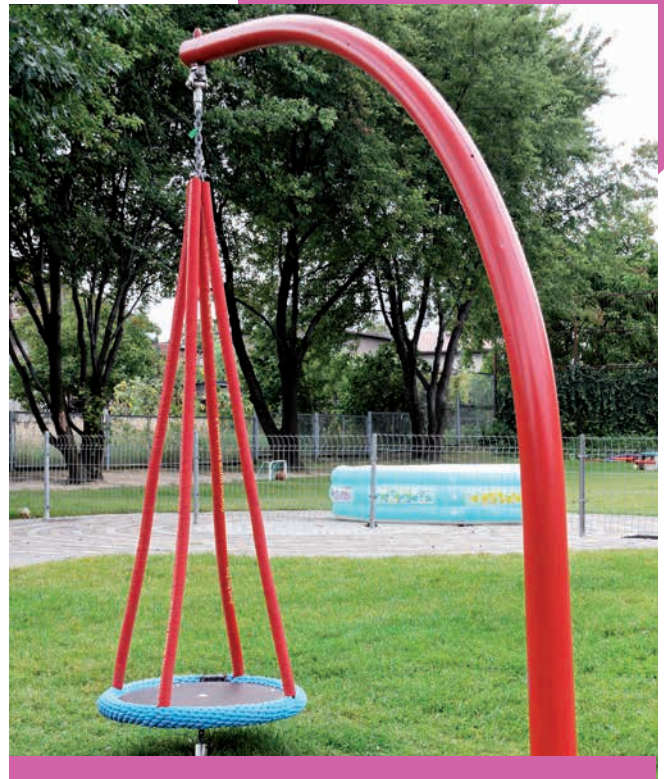

For symbol explanation see folding card at the back

	2.50 m	Equipment 1 Steel posts (Ø 160 mm), hot-dip galvanised, length 3.50 m
	2.05 x 1.00 m	
	14.50 m ²	
	Ø 4.30 m	
	1.50 m	
	1.00 m ³	
	6	

For symbol explanation see folding card at the back

	2.50 m	Equipment 1 Steel posts (Ø 160 mm), hot-dip galvanised, length 3.50 m
	2.05 x 1.00 m	
	14.50 m ²	
	Ø 4.30 m	
	0.55 m	
	0.70 m ³	
	2	







Liana Swing, spinning

Art. No. 20.01.090S



For symbol explanation see folding card at the back

-  3.40 m
-  Ø 3.60 m
-  50.00 m² / 95.00 m²
-  Ø 8.00 m
recommended Ø 11.00 m
-  1.00 m
-  1.25 m³
-  4
- 











Meeting-Point

Art. No. 20.02.134



For symbol explanation see folding card at the back

-  0.60 m
-  4.30 x 4.30 m
-  48.50 m²
-  7.10 x 7.10 m
-  0.60 m
-  2.50 m³
-  34
- 

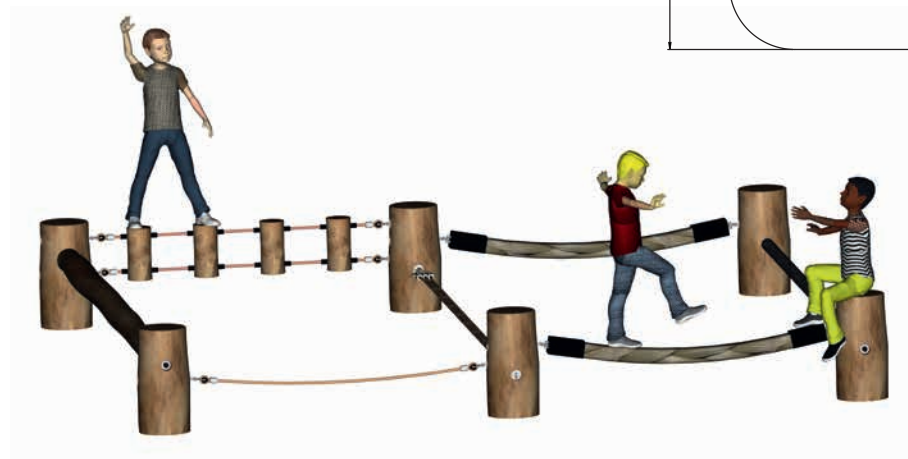
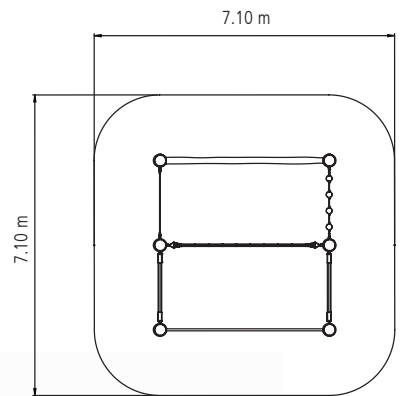

Midi-Climbing Whirl, spinning

Art. No. 20.01.135



Mini Climbing Pyramid, spinning

Art. No. 20.01.070S



For symbol explanation see folding card at the back

	3.00 m
	Ø 2.00 m
	38.50 m ² / 78.55 m ²
	Ø 7.00 m / Ø 10.00 m
	1.70 m
	1.00 m ³
	8

For symbol explanation see folding card at the back

	3.00 m
	Ø 3.50 m
	50.20 m ²
	Ø 8.00 m - Ø 10.00 m
	2.00 m
	1.20 m ³
	15



Diablo, spinning

Art. No. 4592-20



For symbol explanation see folding card at the back

-  3.00 m
-  Ø 1.85 m
-  24.20 m²
-  Ø 5.60 m
recommended Ø 7.00 m
-  2.00 m
-  1.20 m³
-  16
- 

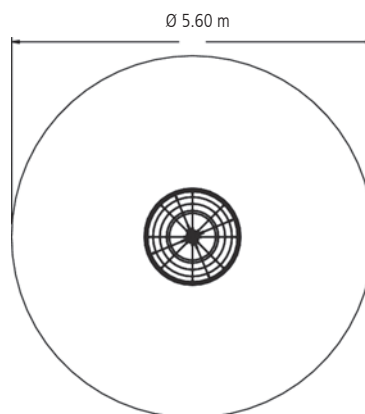









The Look Out

Art. No. 4592-10



For symbol explanation see folding card at the back

-  4.15 m
-  Ø 2.00 m
-  21.70 m²
-  Ø 5.30 m
-  2.10 m
-  1.70 m³
-  23
- 

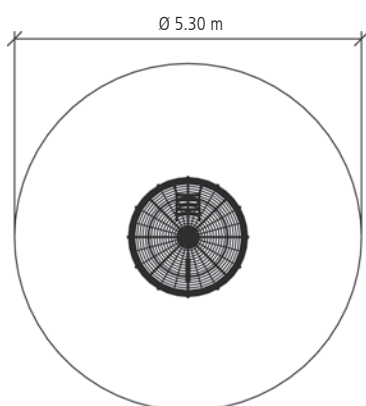
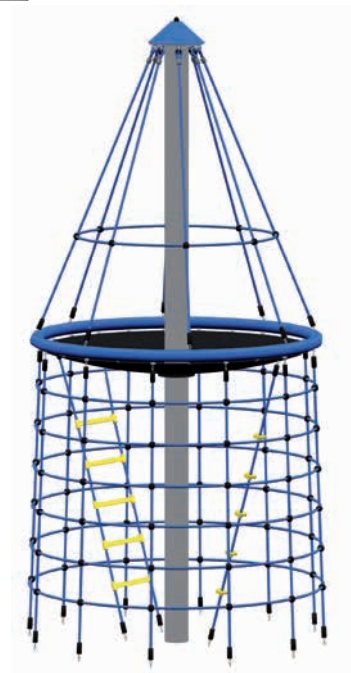



Bird's Nest Carousel, spinning

Art. No. 20.01.080S





Mini Bird's Nest Carousel, spinning









Art. No. 20.06.130 for dig-in ground anchor



For symbol explanation see folding card at the back

-  3.00 m
-  Ø 1.90 m
-  28.25 m²
-  Ø 6.00 m
recommended Ø 9.00 m
-  0.80 m
-  1.20 m³
-  8
- 

For symbol explanation see folding card at the back

-  2.20 m
-  Ø 1.40 m
-  23.75 m²
-  Ø 5.50 m
recommended Ø 8.00 m
-  0.80 m
-  6
- 
- 



Spiral Carousel, spinning

Art. No. 20.01.120S



Nest Carousel, spinning

Art. No. 4594-41



For symbol explanation see folding card at the back

	3.00 m
	Ø 1.90 m
	28.25 m ²
	Ø 7.00 m recommended Ø 10.00 m
	2.00 m
	1.20 m ³
	13

For symbol explanation see folding card at the back

	1.80 m
	Ø 1.20 m
	14.40 m ²
	Ø 4.30 m recommended Ø 6.00 m
	0.45 m
	0.40 m ³
	6

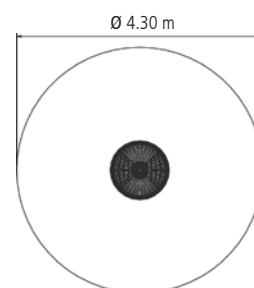











Net Seesaw with wood

Art. No. 4587



For symbol explanation see folding card at the back

-  1.30 m
-  4.35 x 0.90 m
-  26.50 m²
-  7.35 x 3.90 m
-  1.30 m
-  0.80 m³
-  6
- 

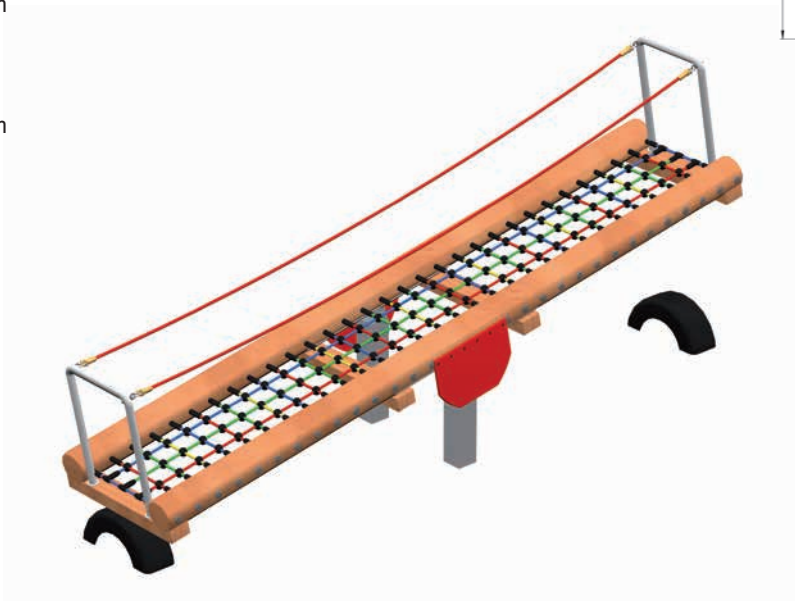
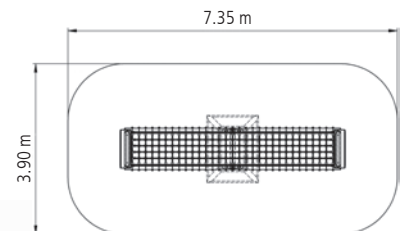









Net Seesaw with steel

Art. No. 4587S



For symbol explanation see folding card at the back

-  1.40 m
-  4.35 x 0.80 m
-  26.00 m²
-  7.35 x 3.80 m
-  1.30 m
-  0.80 m³
-  6
- 

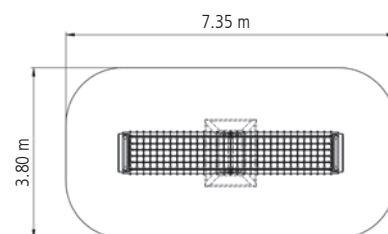



Mushroom Carousel with steel mast, spinning

Art. No. 20.05.110S



For symbol explanation see
folding card at the back



1.20 m



Ø 2.00 m



28.25 m²



Ø 6.00 m



0.90 m



0.40 m³



14











Mini Pirate Tower

Art. No. 4687-30



For symbol explanation see folding card at the back

-  3.85 m
-  4.25 x 4.00 m
-  35.80 m²
-  6.80 x 6.70 m
-  1.45 m
-  1.20 m³
-  24
- 

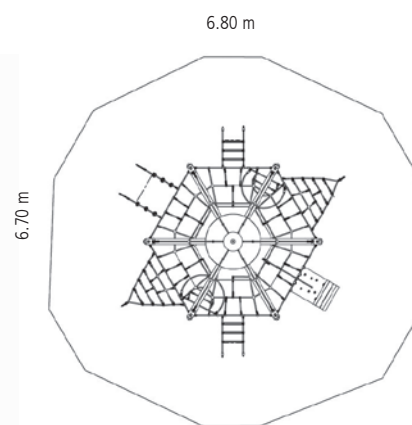

- Q "Fortuna" Mini Pirate Tower (Page 22)
- Q Pirate Tower (Page 89)











Floating Mats

Art. No. 4538-10



For symbol explanation see folding card at the back

-  2.95 m
-  2.95 x 2.95 m
-  30.00 m²
-  5.71 x 5.71 m
-  1.90 m
-  5.30 m³
-  35
- 

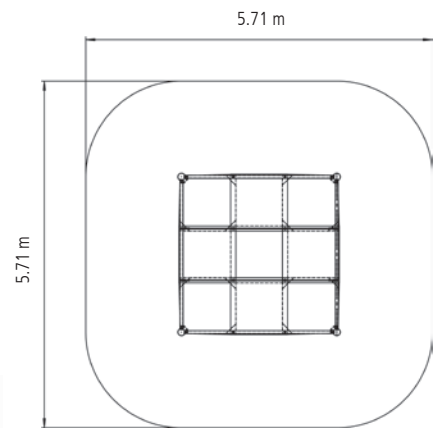

🔍 Rubber mats also available in other colours. Ask us!











Spider Web

Art. No. 4597S Steel posts

Art. No. 4597PS Douglas fir posts, with post shoes



For symbol explanation see folding card at the back

-  2.44 m
-  Ø 3.95 m
-  26.60 m²
-  6.00 x 5.65 m
-  1.50 m
-  2.40 m³
-  16
- 

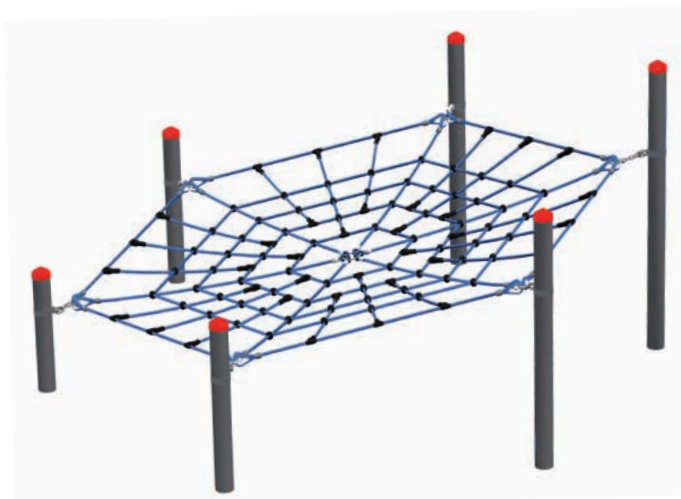
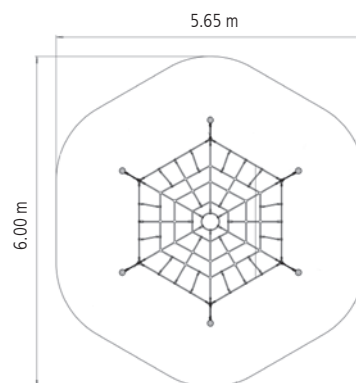

Equipment
6 Steel posts (Ø 102 mm),
hot-dip galvanised,
length 2.40 - 3.40 m,
with plastic cap







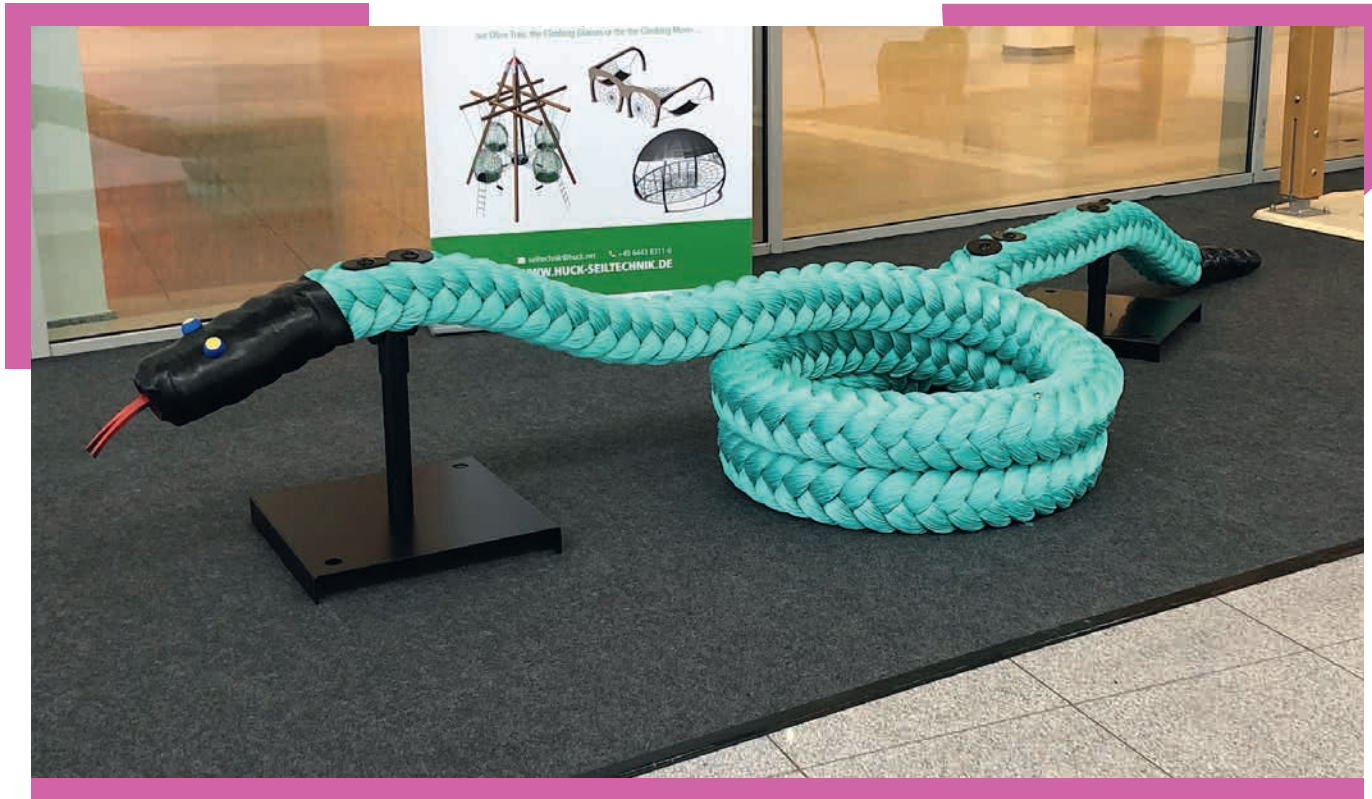

Anaconda Maxi

Art. No. 4591-81AM



Our rope-lengths made from square-braided PP rope. 160 mm Ø (green, blue, black or beige) – in 4 different sizes – are the ideal play comrade for children who would like to practice their balancing. In the same way they are open to crawling through them, laying on them and sitting on them. You can install the equipment in 3 different layouts – depending on the available space requirement (Example Art. 4591-81AM Anaconda Maxi). The frames can be set up individually. Please keep a minimum surrounding distance of 1.50 m.







For symbol explanation see folding card at the back

-  0.65 m
-  5.45 x 5.45 m
-  44.80 m²
-  8.50 x 8.50 m
-  0.65 m
-  27
- 



Slowworm Midi







Art. No. 4591-81BM

-  0.60 m
-  4.25 x 4.15 m
-  32.20 m²
-  7.10 x 7.10 m
-  0.60 m
-  21
- 



Earthworm Mini





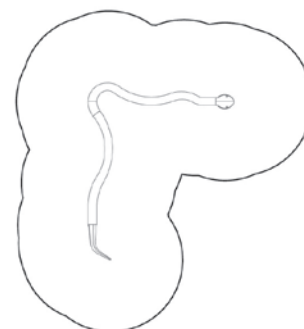

Art. No. 4591-81RM

-  0.60 m
-  3.15 x 3.00 m
-  27.80 m²
-  6.70 x 6.00 m
-  0.60 m
-  10
- 



Green Mamba

Art. No. 4591-81GM

-  0.60 m
-  3.55 x 2.35 m
-  22.90 m²
-  6.50 x 5.10 m
-  0.60 m
-  10
- 

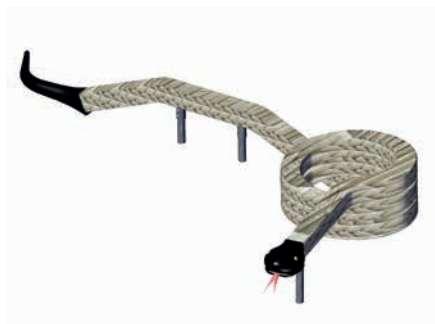

Q Spring-mounted Balancing Lines (Page 66)











Tightrope

Art. No. 4591-73



For symbol explanation see folding card at the back

-  0.65 m
-  6.20 x 1.00 m
-  36.00 m²
-  9.20 x 4.00 m
-  0.65 m
-  1.00 m³
-  20
- 

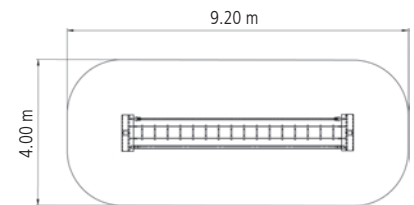

Equipment

2 solid stand constructions made of steel
T-shaped, hot-dip galvanized,
140/140 mm Square, no round tube









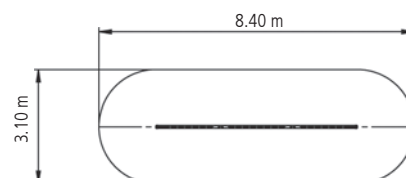

Slackbar

Art. No. 4591-80



For symbol explanation see folding card at the back



-  0.35 m
-  5.30 x 0.10 m
-  23.80 m²
-  8.40 x 3.10 m
-  0.35 m
-  0.65 m³
-  10
- 

Equipment
Pole made of high quality fiberglass
mounted on special flat springs

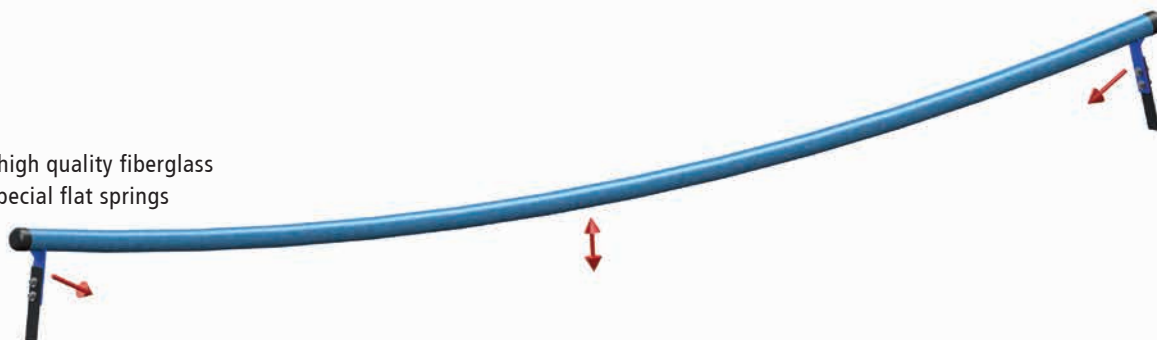











Spring-mounted Balancing Lines

Art. No. 4591-81



For symbol explanation see folding card at the back

-  0.65 m
-  9.55 x 0.20 m
-  37.50 m²
-  12.55 x 3.20 m
-  0.65 m
-  1.00 m³
-  16
- 

Equipment

8 ground anchors, hot-dip galvanized with steel spring (powder coated)

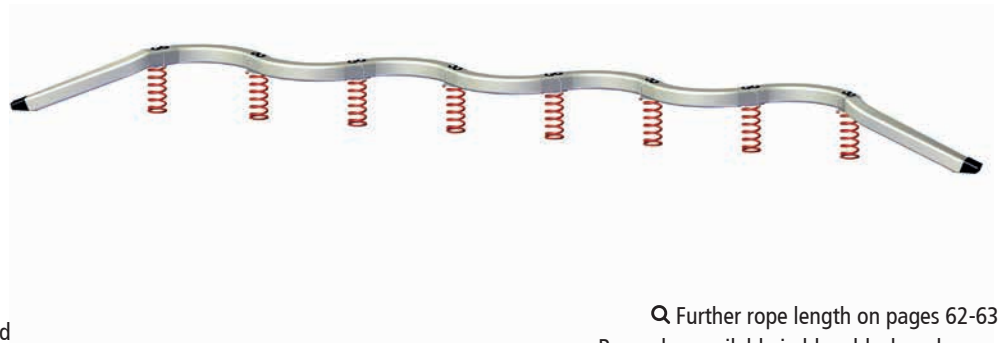
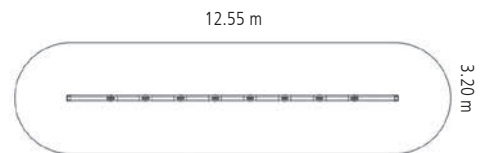

Further rope length on pages 62-63.
Rope also available in blue, black and green.







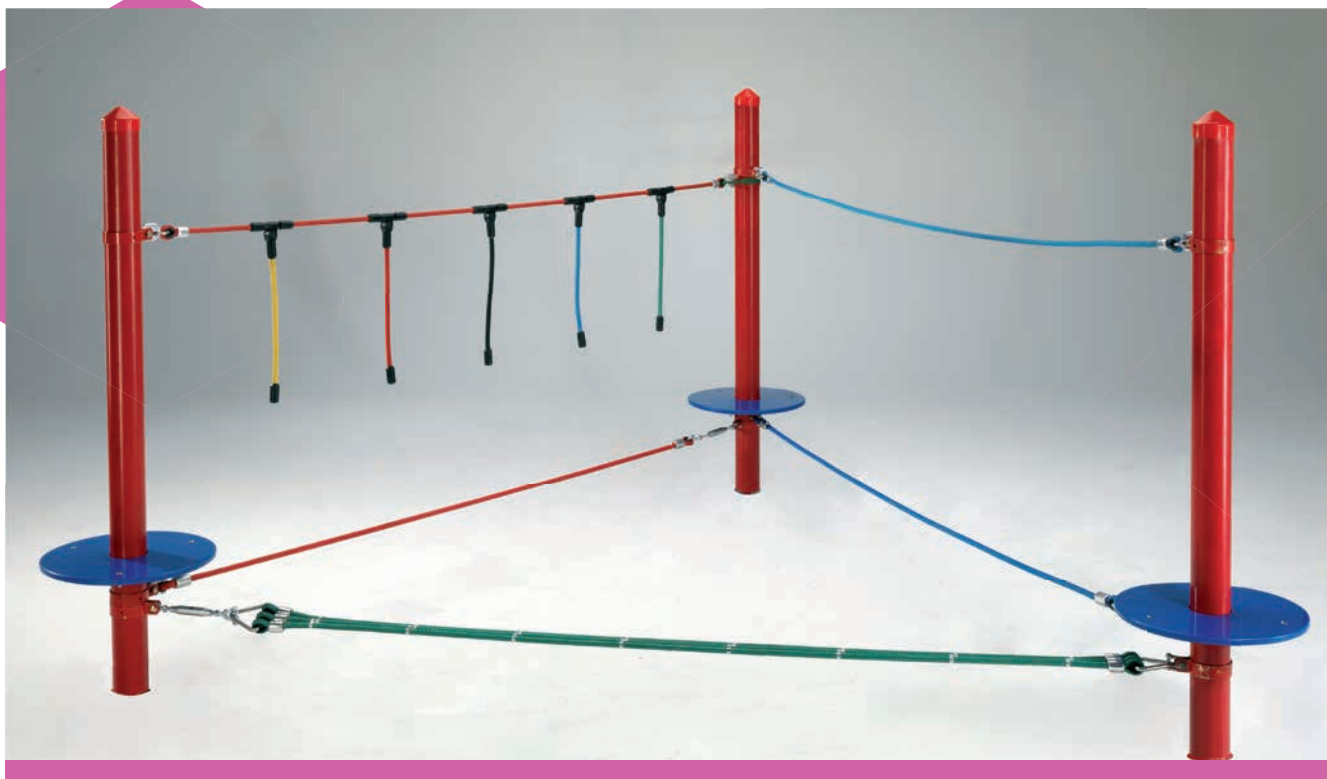



Slackmaster

Art. No. 4591-70-K



For symbol explanation see folding card at the back

-  1.65 m
-  3.50 x 3.10 m
-  29.50 m²
-  6.50 x 6.10 m
-  0.40 m
-  1.00 m³
-  15
- 

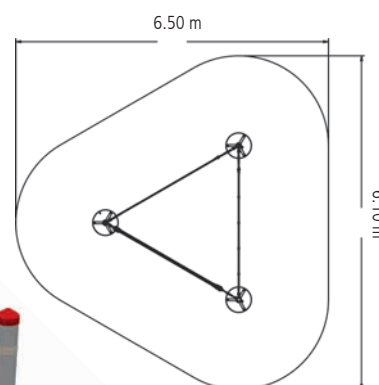
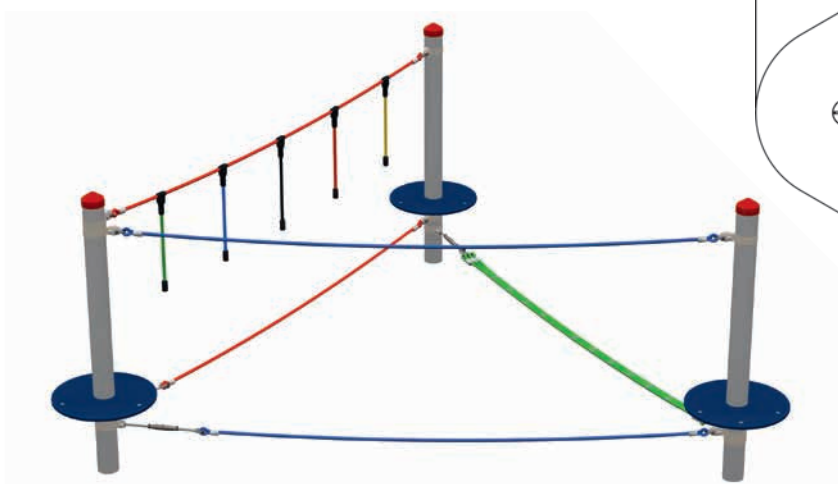

Equipment

- 3 Steel posts (Ø 102 mm), hot-dip galvanised, length 2.40 m, with plastic cap,
- 3 Foot plates made of HDPE (Ø 500 mm)

Each element is available separately and also in different lengths









Slackmaster Combination 1

Art. No. 4591-71 double version

Art. No. 4591-71-1 single version



For symbol explanation see folding card at the back

-  1.44 m
-  3.90 x 3.90 m
-  39.50 m²
-  6.90 x 6.90 m
-  0.50 m
-  1.60 m³
-  14



Equipment
 4 Steel posts (Ø 102 mm),
 hot-dip galvanised, length 2.40 m,
 with plastic cap,
 4 Foot plates made of HDPE (Ø 500 mm)

Diagram
 Art. No. 4591-71-1
 single version

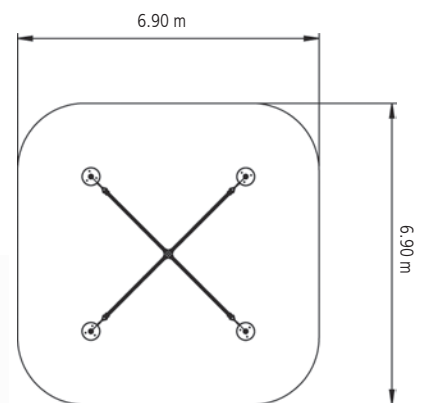
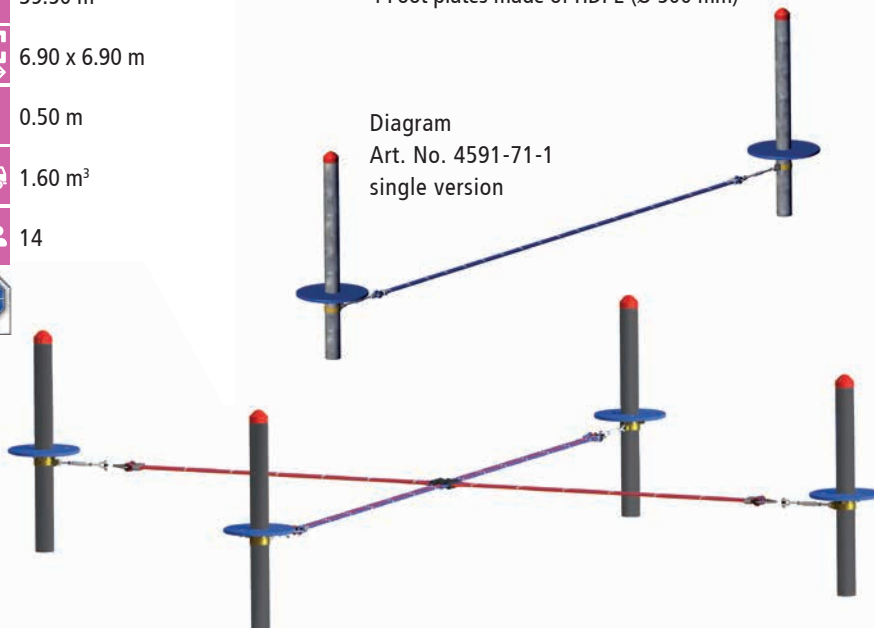









Slackmaster Combination 2

Art. No. 4591-72



For symbol explanation see folding card at the back

-  2.44 m
-  3.50 x 3.50 m
-  37.70 m²
-  6.50 x 6.50 m
-  1.65 m
-  1.60 m³
-  25
- 

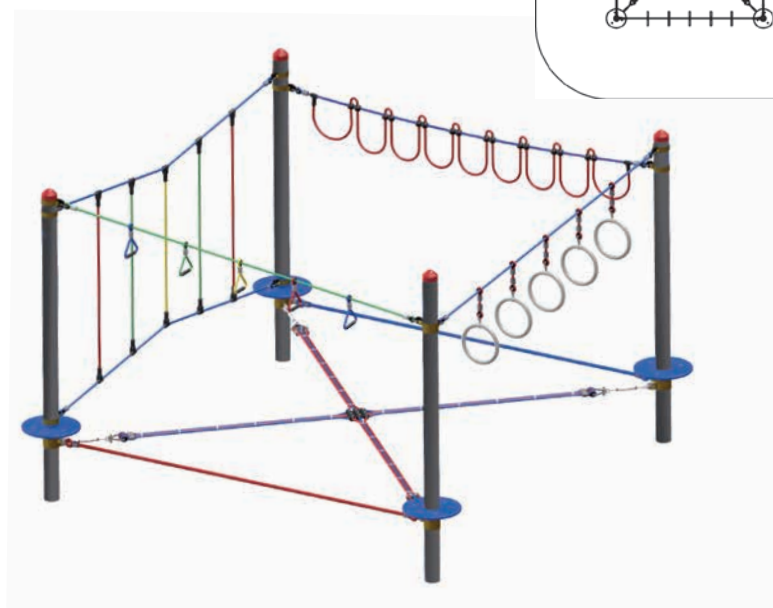
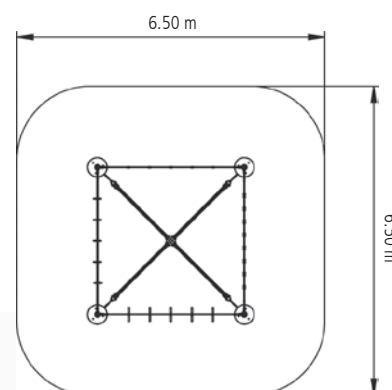

Equipment
 4 Steel posts (Ø 102 mm),
 hot-dip galvanised, length 3.40 m,
 with plastic cap,
 4 Foot plates made of HDPE (Ø 500 mm)









Eagles Nest Platform

Art. No. 4634-70



For symbol explanation see folding card at the back

-  2.25 m
-  4.45 x 4.00 m
-  40.75 m²
-  7.10 x 6.75 m
-  1.45 m
-  2.60 m³
-  34



Equipment

4 Steel posts (Ø 102 mm),
hot-dip galvanised, length 3.00 m,
with plastic cap,
1 Steel centre post (Ø 193 mm),
hot-dip galvanised, length 2.50 m

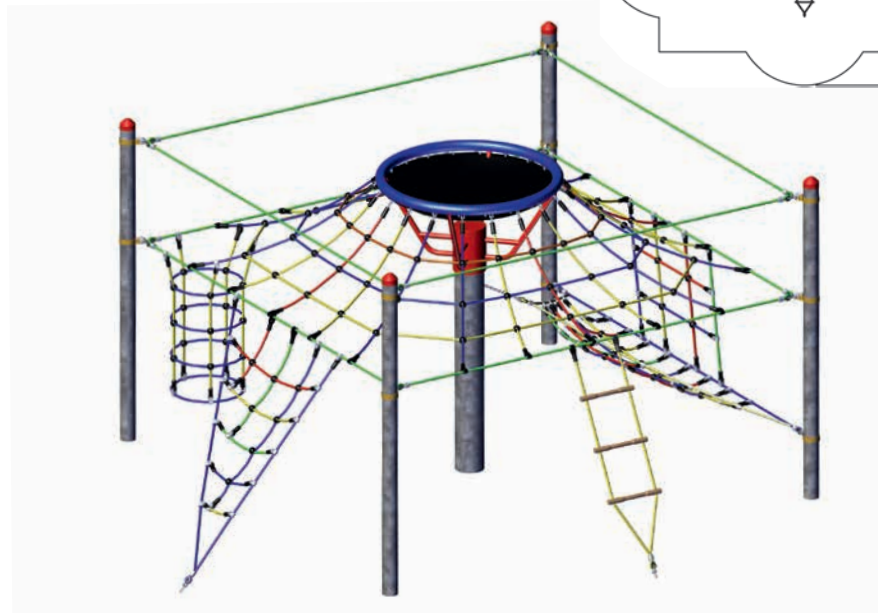
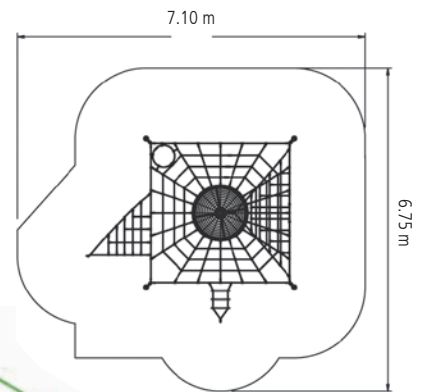









Witch's Coven Version 1

Art. No. 4594-50 Douglas fir posts (Ø 160 mm), with post shoes

Art. No. 4594-50S Steel posts (Ø 102 mm)



For symbol explanation see folding card at the back

-  1.75 m
-  6.40 x 6.25 m
-  54.20 m²
-  9.45 x 9.25 m
-  1.20 m
-  6.00 m³
-  30
- 

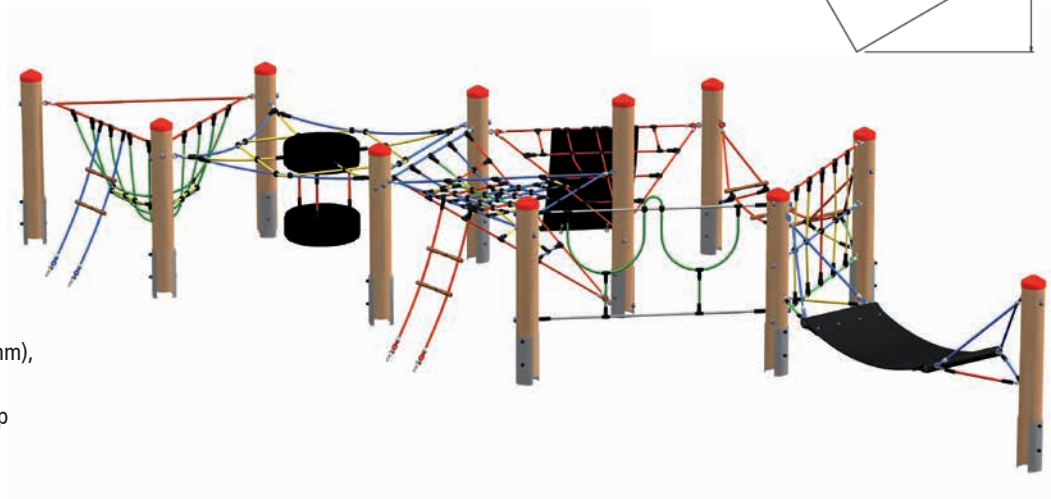
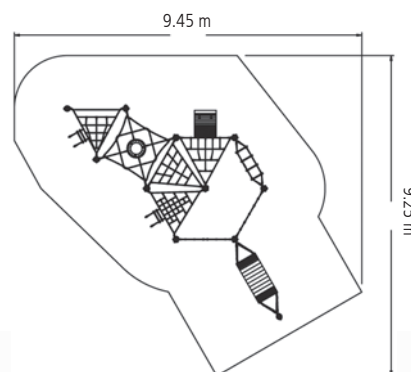

Equipment

11 Douglas fir posts (Ø 160 mm),
length 2.20 m to 2.60 m,
incl. post shoes and plastic cap











Tower Bridge

Art. No. 4960-11



For symbol explanation see folding card at the back

-  2.55 m
-  6.25 x 2.15 m
-  34.30 m²
-  9.25 x 4.65 m
-  0.90 m
-  1.90 m³
-  14
- 

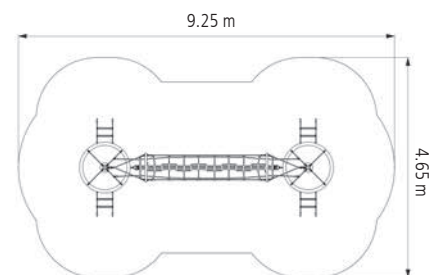

Equipment
2 Steel posts (Ø 102 mm),
hot-dip galvanised, length 3.40 m,
with plastic cap

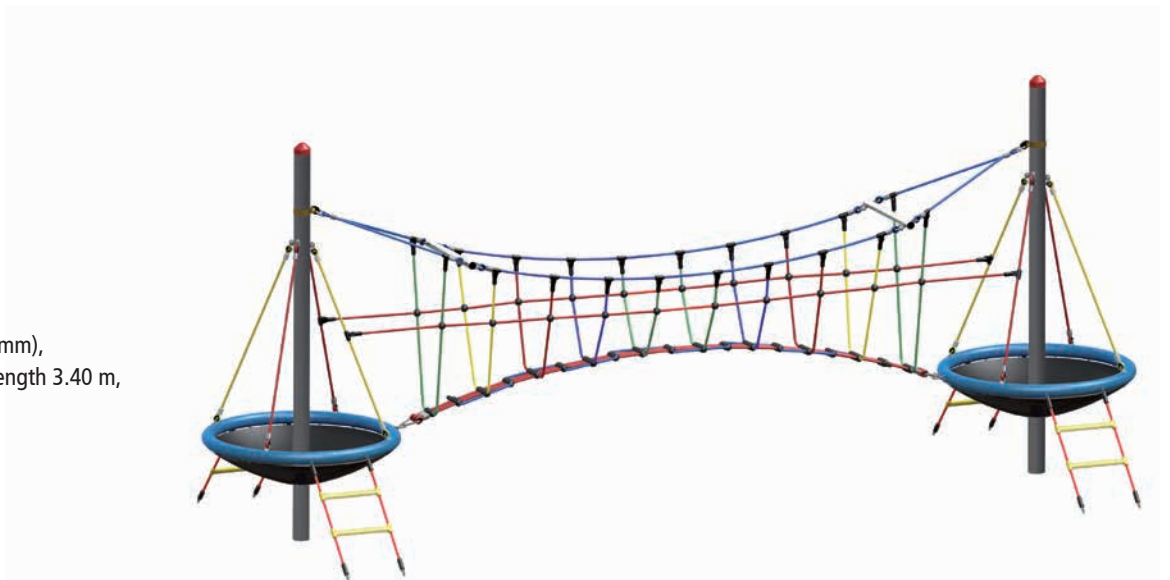









Tent Net

Art. No. 4639-10



For symbol explanation see folding card at the back

-  2.65 m
-  8.80 x 5.80 m
-  64.00 m²
-  11.00 x 7.90 m
-  2.20 m
-  2.10 m³
-  29
- 

Equipment
 2 Steel posts (Ø 102 mm),
 hot-dip galvanised, length 3.50 m,
 with plastic cap

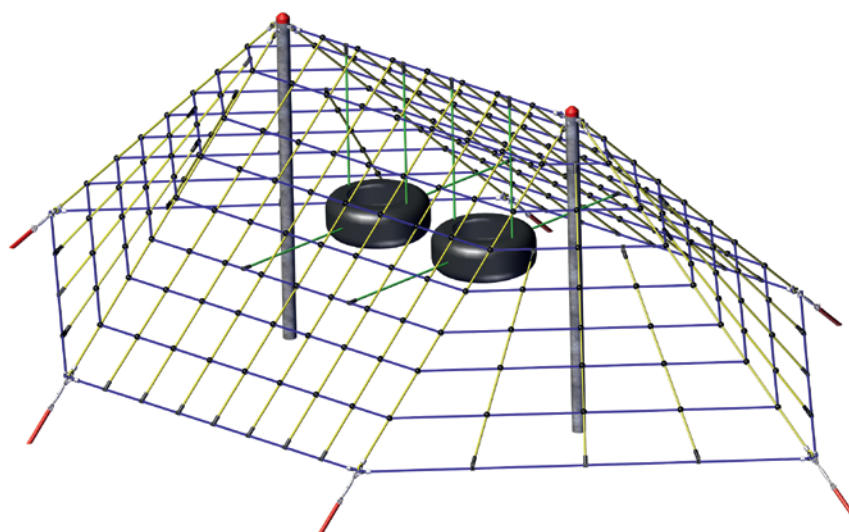
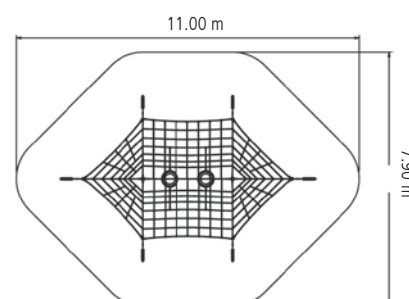



FEEL JOY!



ROPE PLAY EQUIPMENT

For children from the age of 6

HUCK play and climbing equipment for children from the age of 6 is perfect for schools. During breaktimes they can let off steam properly on our climbing and swinging options and can then concentrate much better in lessons after. The multitude of play options the equipment provides promotes creativity and the child's visual motor skills.

PRODUCT HIGHLIGHT

Our impressive climbing device with four "olive caves" not only creates an adventurous climbing experience, but also conveys safety and protection. In the caves, children can play with a lot of imagination and create their own little worlds.



Olive Tree
Page 87





Ellipsis, spinning

Art. No. 20.01.170



For symbol explanation see folding card at the back

-  2.95 m
-  Ø 2.30 m
-  38.50 m²
-  Ø 7.00 m
recommended Ø 10.00 m
-  2.05 m
-  0.70 m³
-  15
- 











Spinning Mushroom

Art. No. 4530-60



For symbol explanation see folding card at the back

-  2.55 m
-  Ø 2.30 m
-  50.00 m²
-  Ø 8.00 m
-  1.60 m
-  1.00 m³
-  8
- 

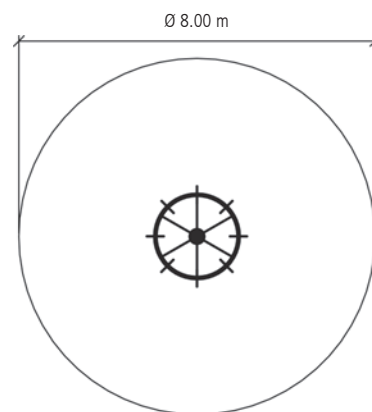

Equipment
 1 Steel post (Ø 160 mm),
 hot-dip galvanised,
 length 3.00 m, with cap











Bow Net

Art. No. 4960-15



For symbol explanation see folding card at the back

-  3.05 m
-  5.15 x 2.70 m
-  24.90 m²
-  6.70 x 5.10 m
-  2.20 m
-  3.10 m³
-  11
- 

Equipment
2 Steel posts (Ø 159 mm),
hot-dip galvanised, length 3.90 m / 2.90 m,
with plastic cap

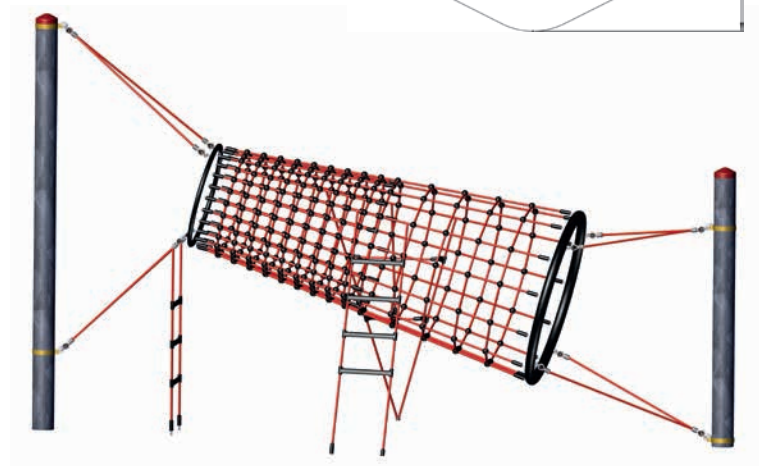
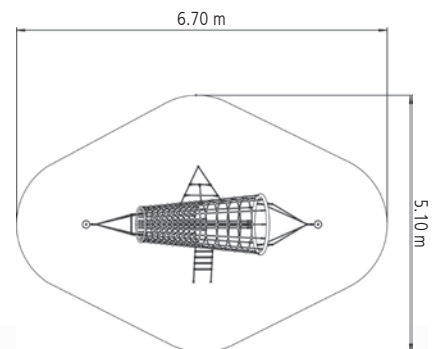







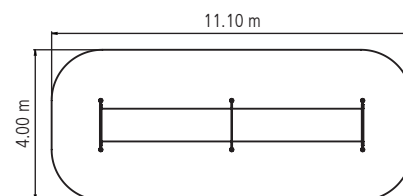

Rubber Jumper

Art. No. 4951



For symbol explanation see folding card at the back



-  0.70 m
-  8.10 x 1.40 m
-  44.30 m²
-  11.10 x 4.00 m
-  0.70 m
-  1.80 m³
-  20
- 

Equipment
 6 Steel posts (Ø 102 mm),
 hot-dip galvanised, length 1.50 m / 1.40 m,
 with plastic cap













Hexagon Tower

Art. No. 4631-50



For symbol explanation see folding card at the back

-  4.00 m
-  Ø 9.85 m
-  76.00 m²
-  Ø 9.85 m
-  3.00 m
-  12.00 m³
-  45
- 

Equipment

6 Robinia wood posts (Ø 250 – 350 mm), Splinter free, as grown, length 5.00 m, mitre top at 100 mm, with steel post shoes

Ø 9.85 m

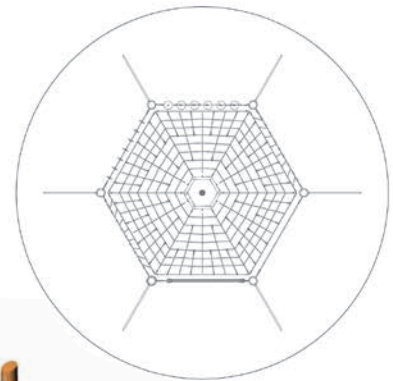

Please note!

The space required for foundations (assembly space) is bigger than the minimum space requirement for the equipment.











Climbing Glasses

Art. No. 4580-5K



For symbol explanation see folding card at the back

-  2.00 m
-  6.25 x 4.95 m
-  68.20 m²
-  9.25 x 8.25 m
-  2.00 m
-  6.30 m³
-  44
- 

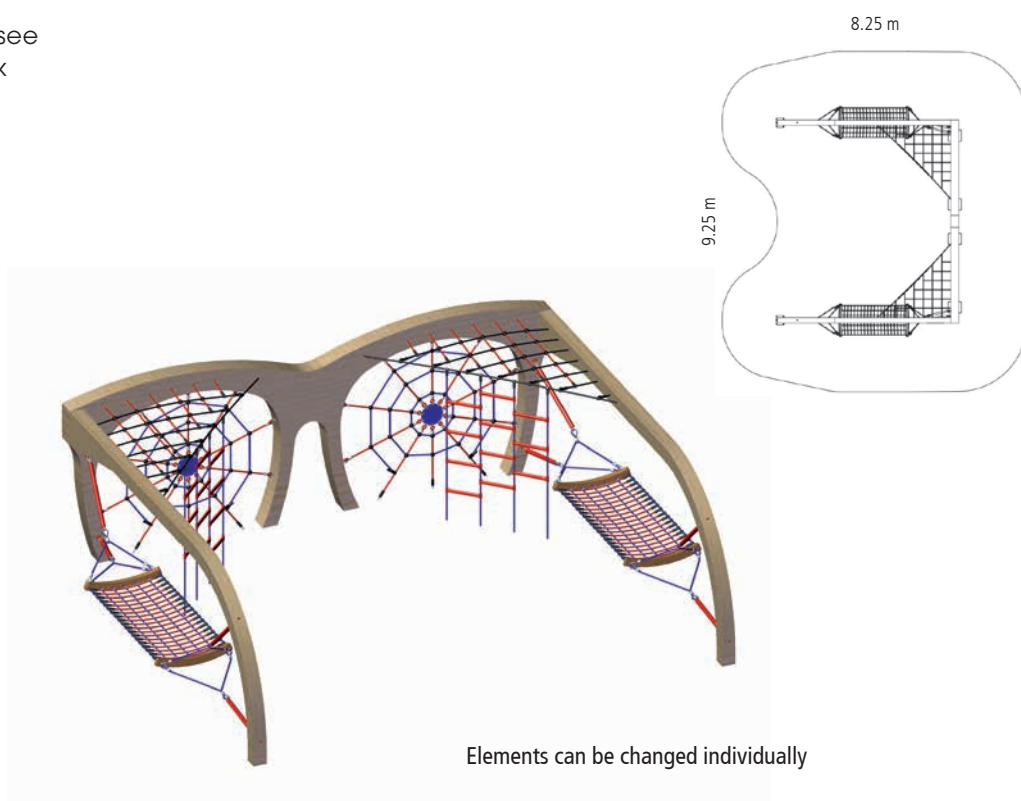











Climb and Chill

Art. No. 6200



For symbol explanation see folding card at the back

-  2.40 m
-  4.90 x 2.15 m
-  47.40 m²
-  8.05 m x 6.30 m
-  2.40 m
-  3.50 m³
-  24
- 

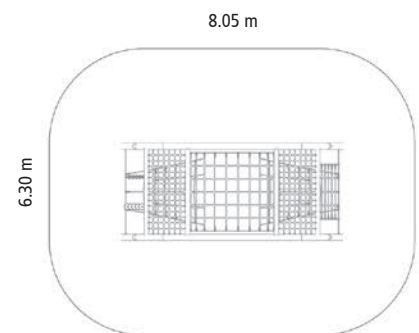

Play equipment as shown in 3D image











Climbing Palm

Art. No. 4653



For symbol explanation see folding card at the back

-  6.00 m
-  5.80 x 11.80 m
-  97.20 m²
-  12.85 x 9.10 m
-  2.90 m
-  3.00 m³
-  46
- 

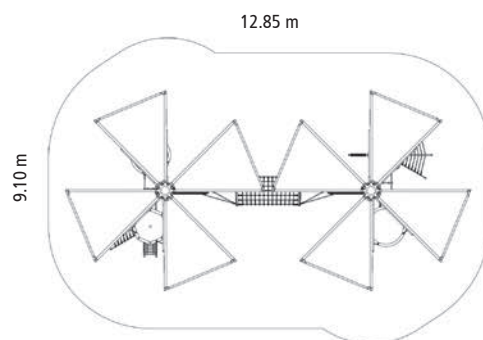



Climbing Whirl, spinning

Art. No. 20.01.130S



For symbol explanation see folding card at the back

-  4.20 m
-  Ø 3.50 m
-  50.00 m²
-  Ø 8.00 m
recommended Ø 11.00 m
-  2.50 m
-  1.00 m³
-  20
- 











Midi Climbing Tepee

Art. No. 4587-22



For symbol explanation see folding card at the back

-  3.65 m
-  3.40 x 3.40 m
-  32.40 m²
-  5.85 x 5.85 m
-  2.20 m
-  2.20 m³
-  25
- 

Equipment
4 Steel posts (Ø 102 mm),
hot-dip galvanised, length 5.00 m

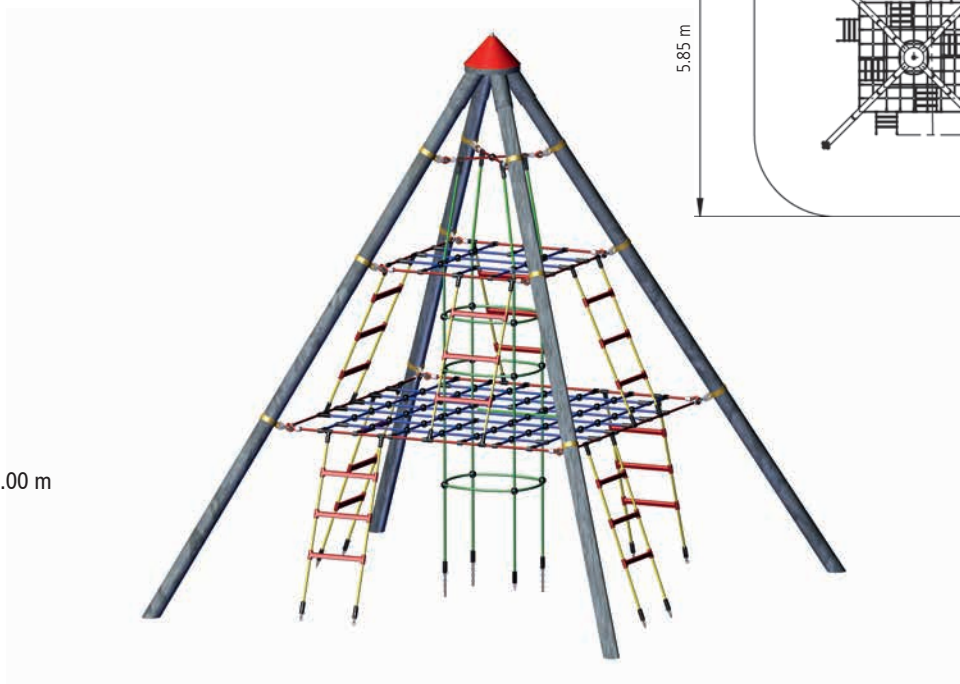



Large Climbing Pyramid, spinning

Art. No. 20.01.060S

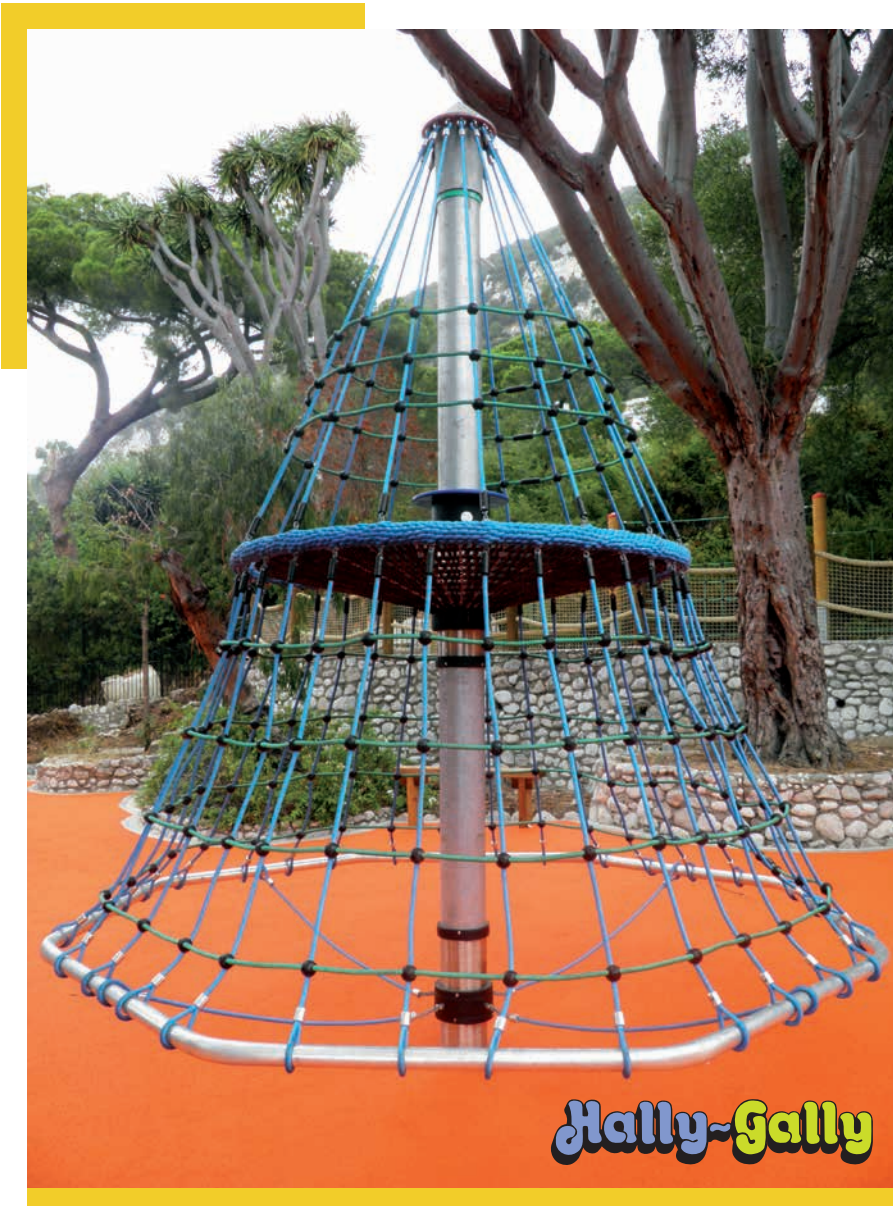

For symbol explanation see folding card at the back

-  4.20 m
-  Ø 3.50 m
-  50.00 m²
recommended 95.00 m²
-  Ø 8.00 m
recommended Ø 11.00 m
-  2.80 m
-  1.00 m³
-  20
- 

Hally-Gally











Olive Tree

Art. No. 4652-24



For symbol explanation see folding card at the back

-  7.15 m
-  6.60 x 6.60 m
-  62.00 m²
-  9.50 x 9.50 m
-  3.00 m
-  2.10 m³
-  74
- 

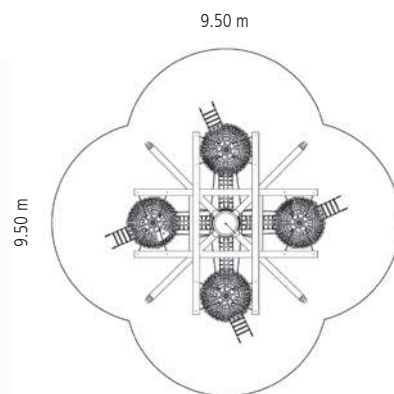











"Black Beard" Pirate Ship

Art. No. 4687-25 wood crossbeams

Art. No. 4687-25S steel crossbeams



For symbol explanation see folding card at the back

-  5.20 m
-  11.70 x 3.95 m
-  71.30 m²
-  15.15 x 7.00 m
-  2.70 m
-  3.90 m³
-  43
- 

Equipment
 1 Steel post (Ø 160 mm),
 hot-dip galvanised,
 length 6.00 m
 3 Steel posts (Ø 102 mm),
 length 3.50 m
 with plastic cap

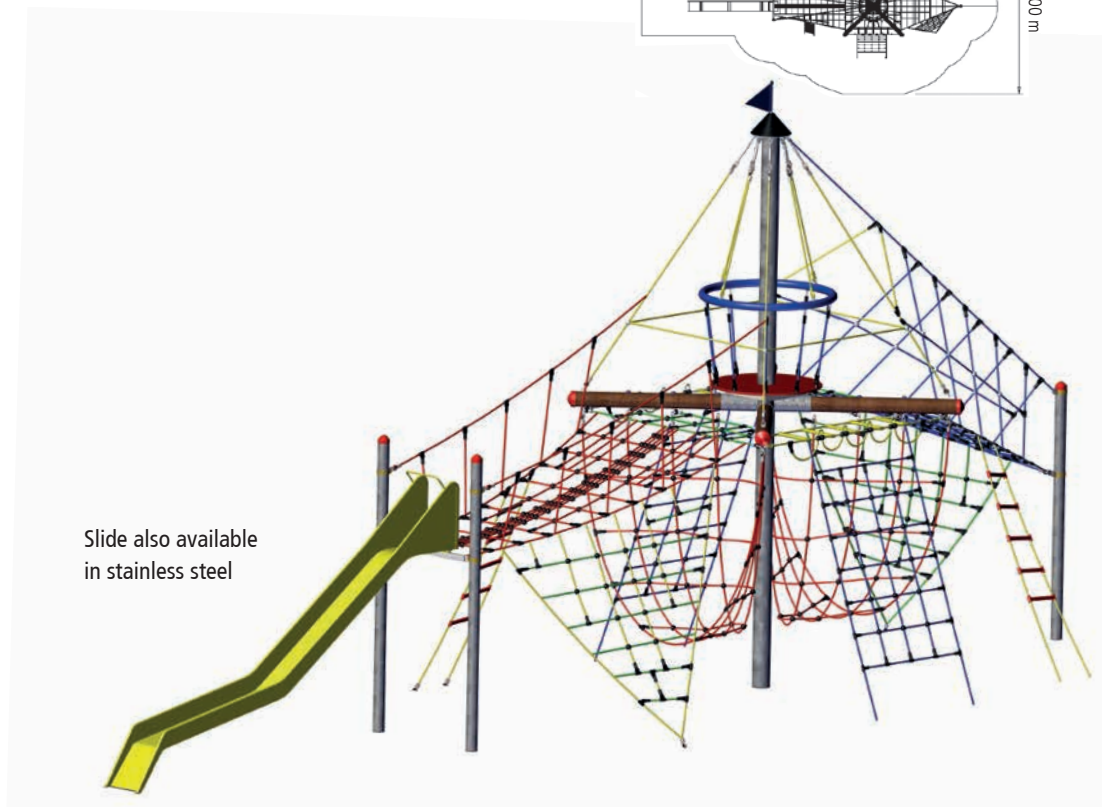
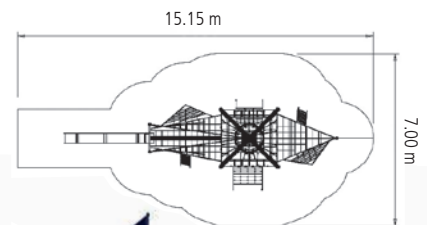









Pirate Tower

Art. No. 4687-20 wood crossbeams

Art. No. 4687-20S steel crossbeams



For symbol explanation see folding card at the back

-  5.50 m
-  3.75 x 2.55 m
-  44.40 m²
-  7.00 x 7.00 m
-  2.70 m
-  1.60 m³
-  25
- 

Equipment

1 Steel post (Ø 160 mm),
hot-dip galvanised,
length 6.00 m,
4 steel cross-beams (Ø 139.7 mm),
length 1.64 m, with plastic cap

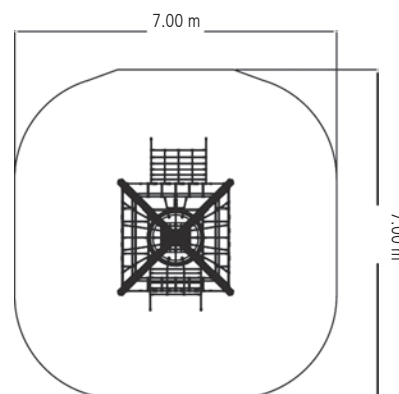
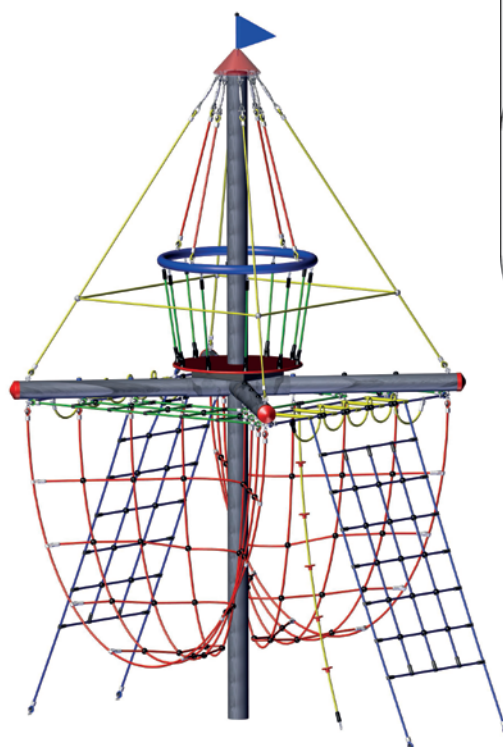









Space Capsule, spinning

Art. No. 20.01.020S



For symbol explanation see
folding card at the back

-  3.40 m
-  Ø 3.50 m
-  50.25 m²
-  Ø 8.00 m
recommended Ø 11.00 m
-  2.00 m
-  1.00 m³
-  19
- 











Hourglass

Art. No. 4592



For symbol explanation see folding card at the back

-  5.20 m
-  Ø 3.00 m
-  38.50 m²
-  Ø 7.00 m
-  max. 3.00 m
-  1.70 m³
-  19
- 

Equipment
 1 Steel post (Ø 160 mm),
 hot-dip galvanised,
 length 6.00 m

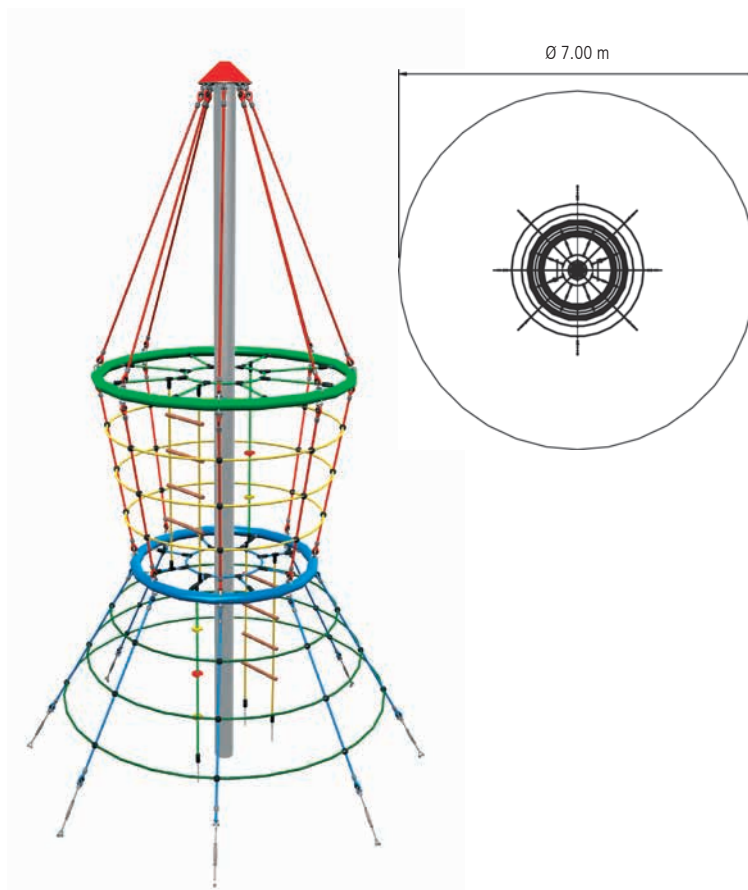









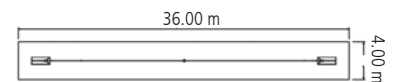

Aerial Runway, with buried ground anchor

Art. No. 4581B



For symbol explanation see folding card at the back



-  3.55 m
-  0.16 x 33.10 m
-  144 m²
-  36.00 x 4.00 m
-  1.50 m
-  6.80 m³
-  1
- 

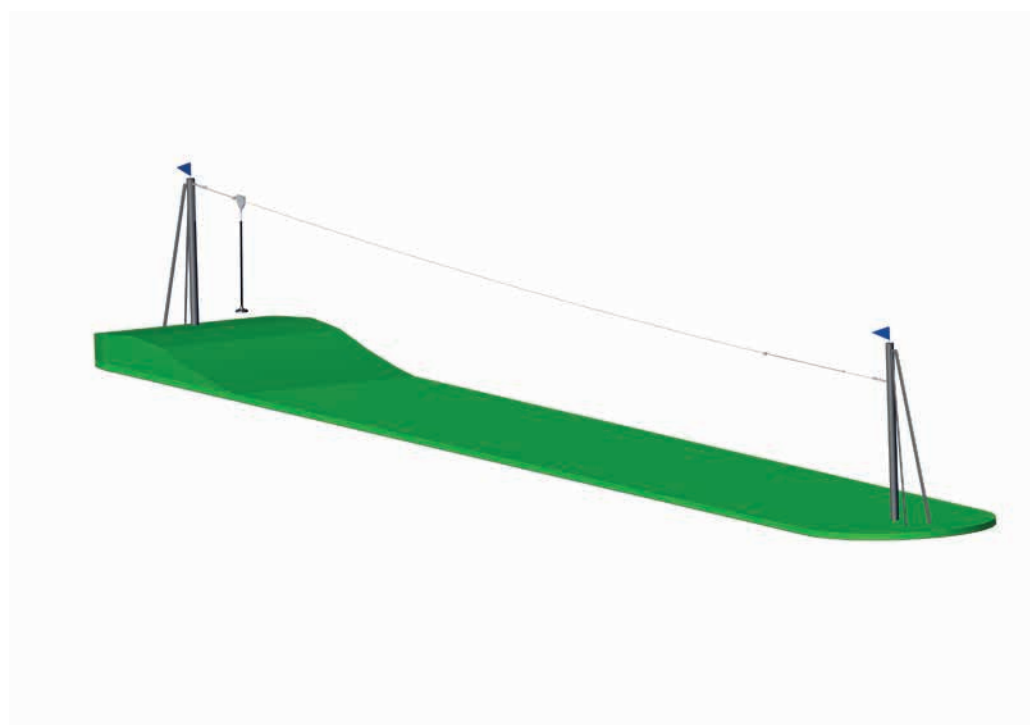







Serpent - The Snake

Art. No. 20.02.000



Picture shows standard version

For symbol explanation see folding card at the back

-  1.90 m
-  8.90 x 12.00 m
-  135.00 m²
-  14.95 x 12.20 m
-  1.90 m
-  35
- 

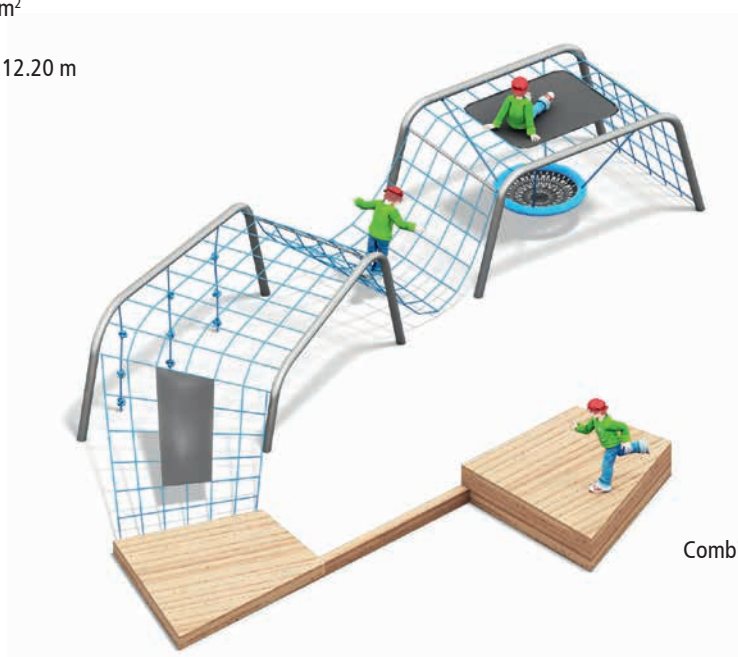
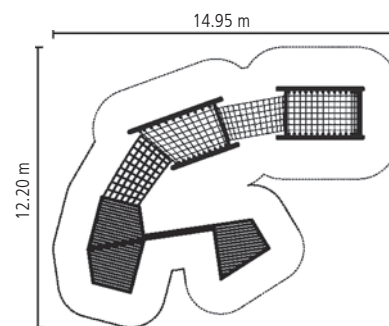

Combination example

- ⊕ Ready-made foundations are included in delivery
- ⊕ Made from stainless steel tubes











Tipi

Art. No. 20.02.137



For symbol explanation see folding card at the back

-  5.20 m
-  Ø 4.50 m
-  75.30 m²
-  Ø 9.80 m
-  2.90 m
-  2.00 m
-  34
- 









Tower Carousel, spinning

Art. No. 20.01.150S



For symbol explanation see folding card at the back

-  4.20 m
-  Ø 2.00 m
-  50.20 m²
-  Ø 8.00 m
recommended Ø 11.00 m
-  2.80 m
-  1.00 m³
-  12
- 











Bird's Nest Tree "Drago"

Art. No. 4652-70



For symbol explanation see folding card at the back

-  5.95 m
-  Ø 4.55 m
-  54.00 m²
-  Ø 8.30 m
-  2.60 m
-  4.90 m³
-  28
- 



Ø 8.30 m

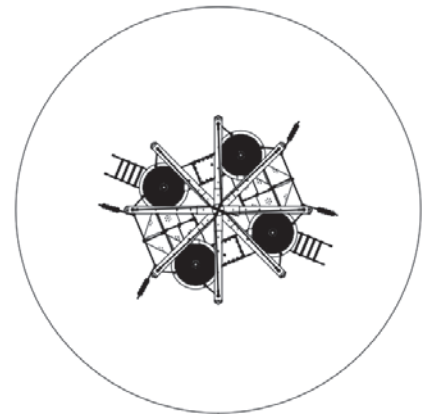









Bird's Nest Tree

Art. No. 4652 wood crossbeams

Art. No. 4652S steel crossbeams



For symbol explanation see folding card at the back

-  5.95 m
-  Ø 7.70 m
-  81.00 m²
-  Ø 10.20 m
-  2.80 m
-  3.20 m³
-  54
- 

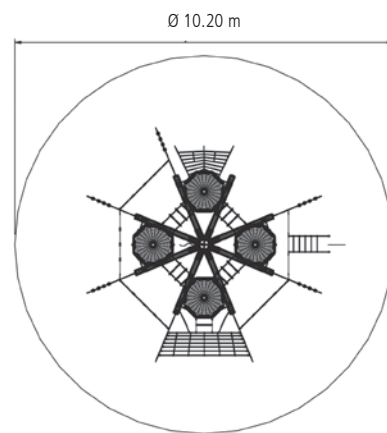
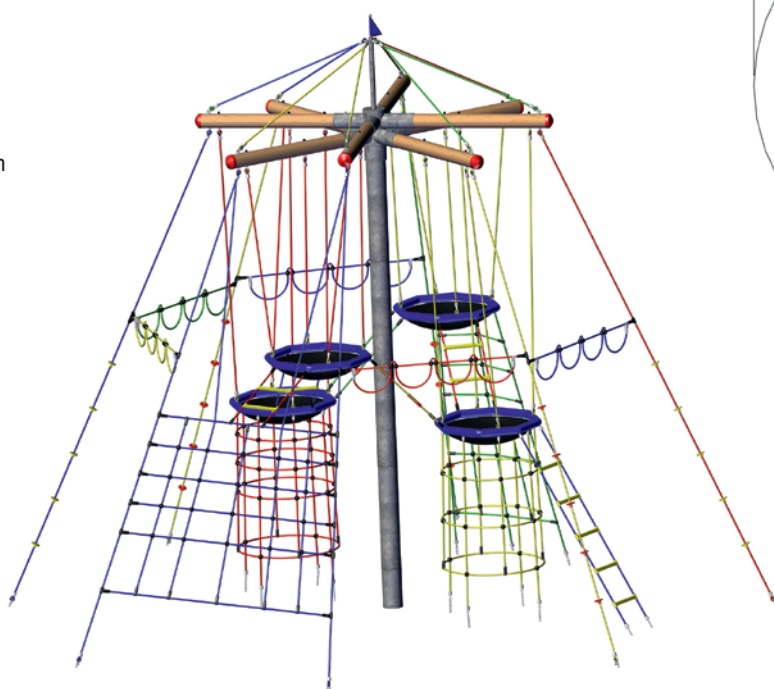

- Q Mini Bird's Nest Tree (Page 25)
- Q Bird's Nest Tree Midi (Page 102)

Hot-dipped galvanised steel cross beams are available upon request
Further elements such as a slide can be added.











Eagles Nest Tree

Art. No. 4652-40 wood crossbeams

Art. No. 4652-40S steel crossbeams



For symbol explanation see folding card at the back

-  5.95 m
-  Ø 4.00 m
-  52.80 m²
-  Ø 8.20 m
-  2.95 m
-  2.50 m³
-  35
- 

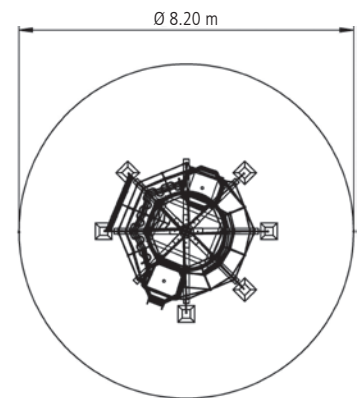
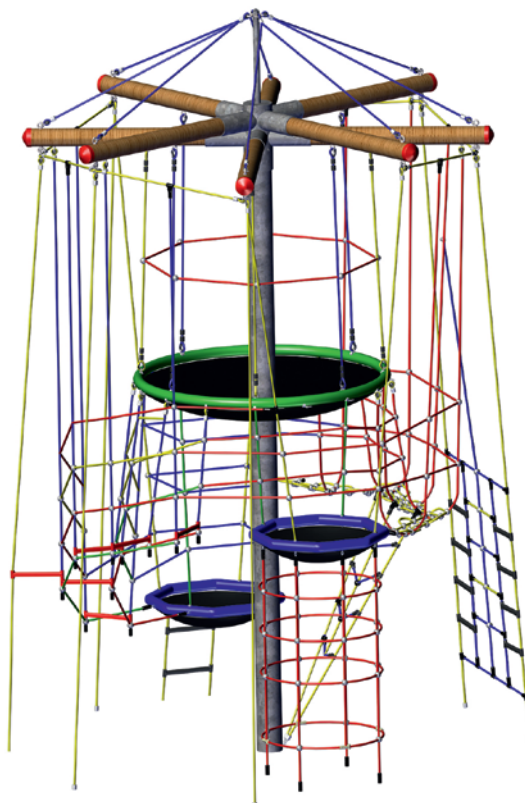

Hot-dipped galvanised steel cross beams are available upon request. See right hand picture above. Further elements such as a slide can be added.











Bird's Nest Tree "Laola"

Art. No. 4652-60



For symbol explanation see folding card at the back

-  6.00 m
-  7.25 x 7.15 m
-  48.20 m²
-  9.50 x 7.95 m
-  2.50 m
-  7.50 m³
-  66
- 

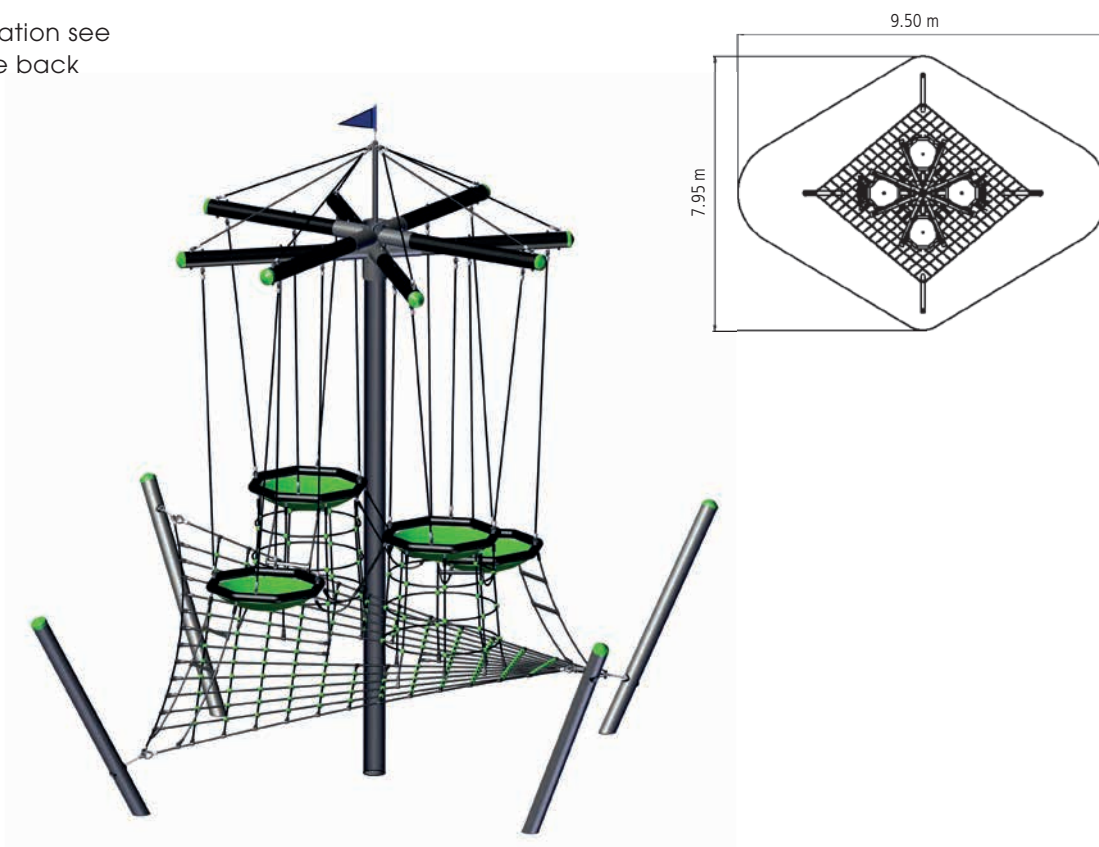



Bird's Nest Tree, with bridge and slide

Art. No. 4652-2 Wood crossbeams

Art. No. 4652-2S Steel crossbeams



For symbol explanation see
folding card at the back

-  5.95 m
-  13.00 x 7.10 m
-  101.00 m²
-  16.45 x 10.20 m
-  2.80 m
-  4.40 m³
-  67
- 

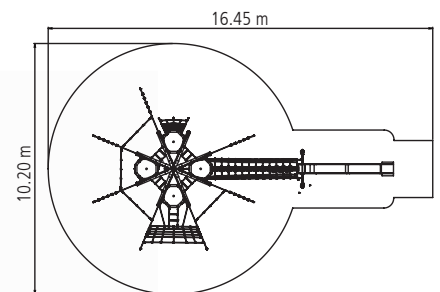
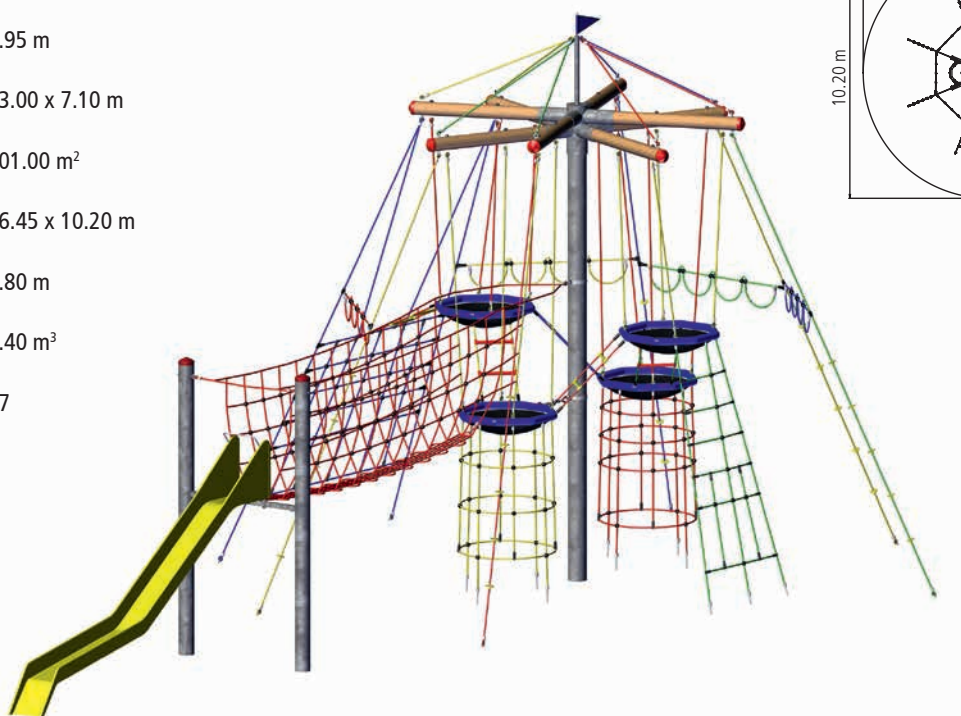





Bird's Nest Tree, with bridge and spiral slide

Art. No. 4652-3 Wood crossbeams

Art. No. 4652-3S Steel crossbeams



For symbol explanation see folding card at the back

-  5.95 m
-  12.55 x 7.10 m
-  104.00 m²
-  16.20 x 10.20 m
-  2.80 m
-  4.75 m³
-  74
- 

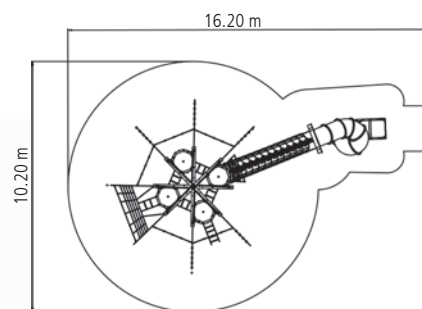
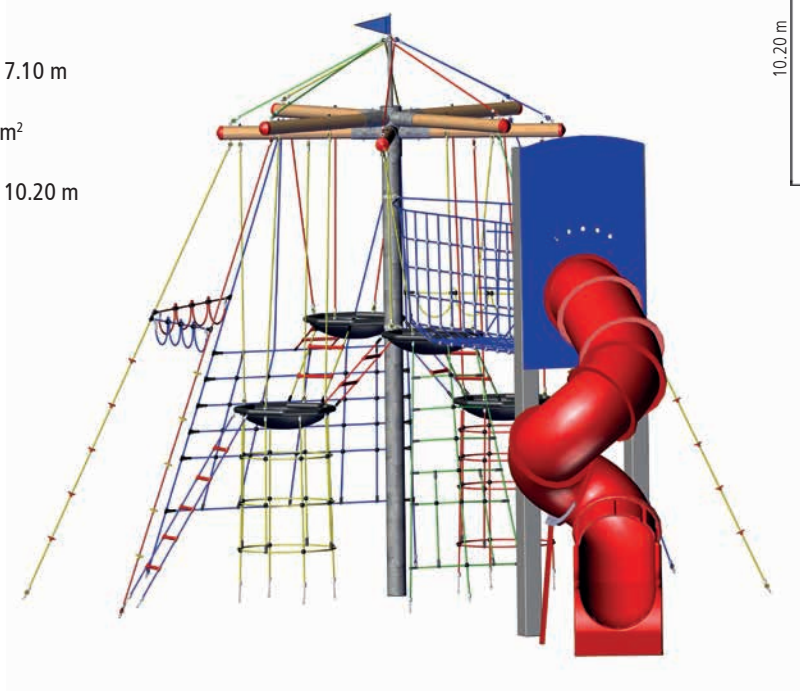

Hot-dipped galvanised steel cross beams are available upon request. Upon request also available with straight slide.











Bird's Nest Tree Midi

Art. No. 4652-10 Wood crossbeams

Art. No. 4652-10S Steel crossbeams



For symbol explanation see folding card at the back

-  5.20 m
-  Ø 3.65 m
-  44.20 m³
-  Ø 7.50 m
-  2.00 m
-  2.70 m³
-  42
- 

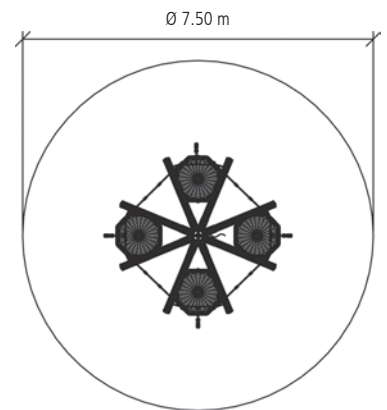

Q Mini Bird's Nest Tree (Page 25)

Q Bird's Nest Tree (Page 97)

Hot-dipped galvanised steel cross beams are available upon request. Further elements such as a slide can be added.





Bird's Nest Tower "Black Forest"-Combi

Art. No. 4652-23



For symbol explanation see folding card at the back

-  6.90 m
-  10.40 x 8.20 m
-  127.00 m²
-  13.70 x 12.10 m
-  2.95 m
-  7.00 m³
-  107
- 

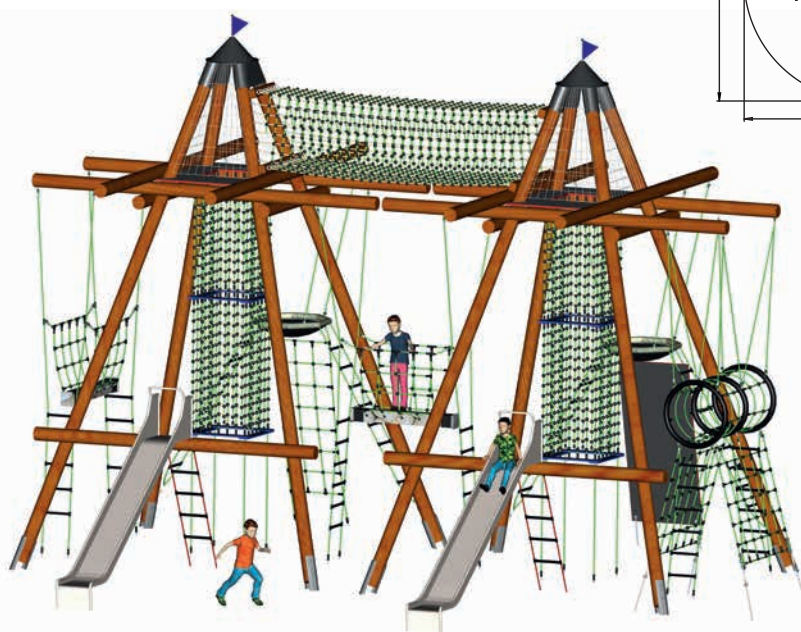
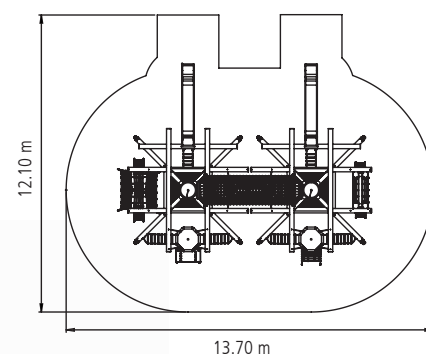











Bird's Nest Tower

Art. No. 4652-20S, with steel posts



For symbol explanation see folding card at the back

-  7.15 m
-  7.10 x 6.85 m
-  78.50 m²
-  Ø 10.00 m
-  2.90 m
-  2.50 m³
-  32
- 

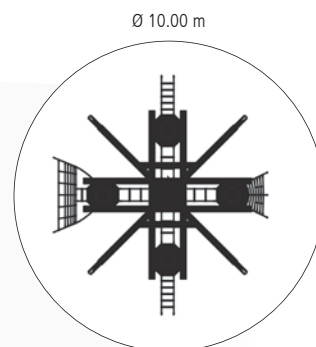
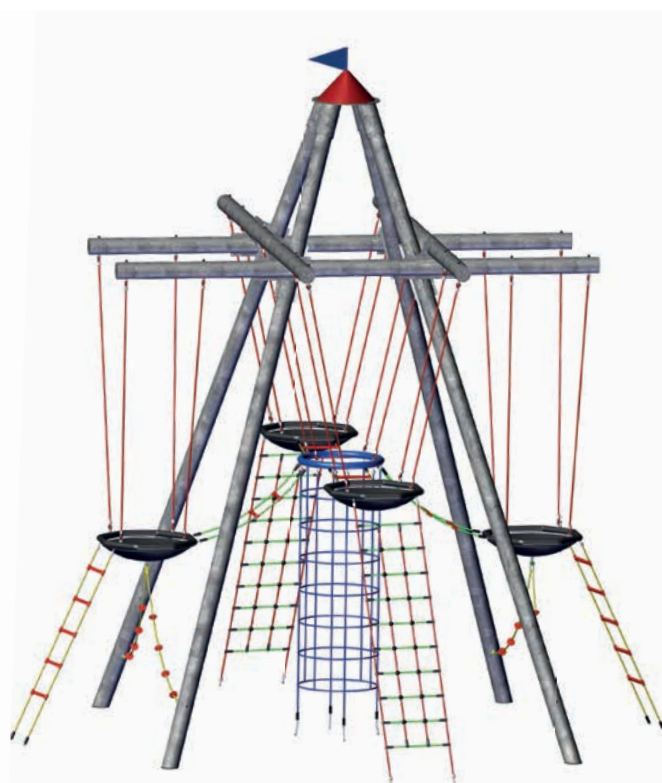









Bird's Nest Tower

Art. No. 4652-20, with wood posts



For symbol explanation see folding card at the back

-  7.15 m
-  7.10 x 6.85 m
-  78.50 m²
-  Ø 10.00 m
-  2.90 m
-  2.50 m³
-  32
- 



Ø 10.00 m

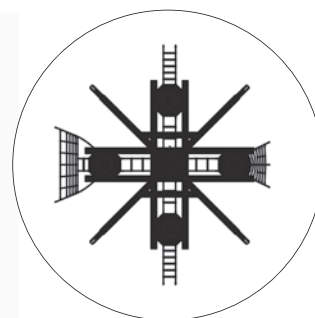

Q "Fortuna" Bird's Nest Tower (Page 26)

Q Olive Tree (Page 87)









Bird's Nest Tower "Black Forest"

Art. No. 4652-21S, with steel posts



For symbol explanation see folding card at the back

-  7.15 m
-  5.60 x 8.15 m
-  82.70 m²
-  9.90 x 12.10 m
-  3.00 m
-  4.00 m³
-  64
- 

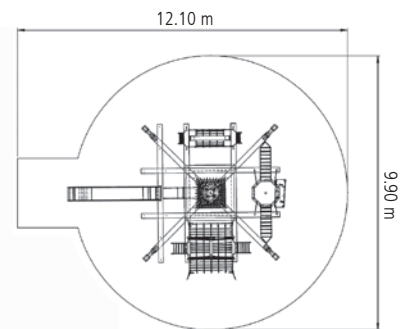
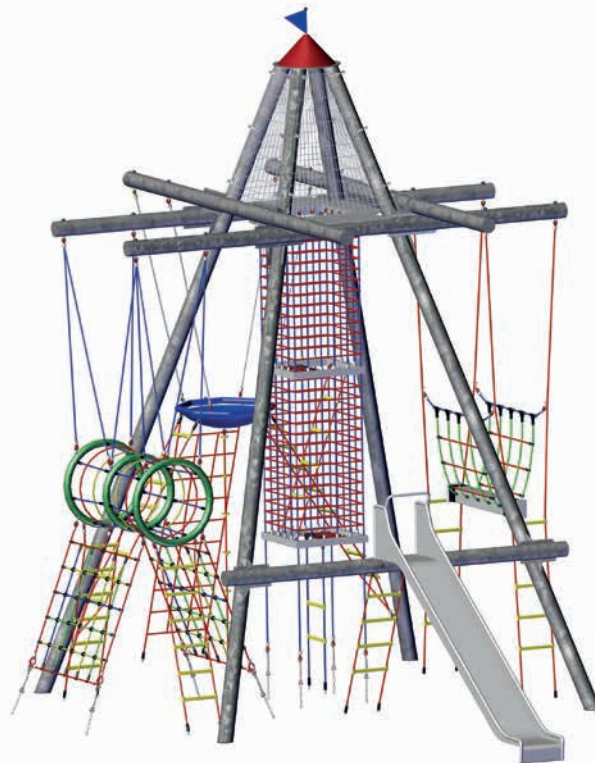









Bird's Nest Tower "Black Forest"

Art. No. 4652-21, with wood posts



For symbol explanation see folding card at the back

-  7.15 m
-  5.60 x 8.15 m
-  82.70 m²
-  9.90 x 12.10 m
-  3.00 m
-  4.00 m³
-  64
- 

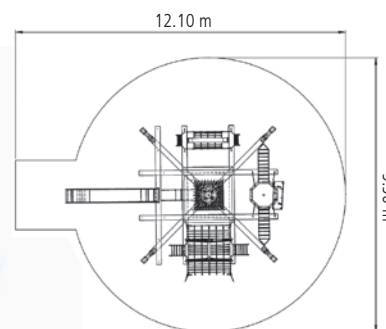









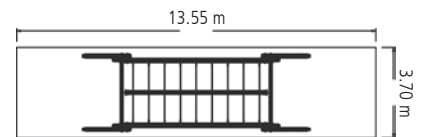

Viking Swinger

Art. No. 4585-60



For symbol explanation see folding card at the back



-  3.50 m
-  9.40 x 3.00 m
-  50.00 m²
-  13.55 x 3.70 m
-  1.90 m
-  6.50 m³
-  10
- 



Please note!
The space required for foundations (assembly space) is bigger than the minimum space requirement for the equipment.











Dragon Swinger

Art. No. 4585-10



For symbol explanation see folding card at the back

-  5.40 m
-  7.05 x 15.90 m
-  58.80 m²
-  15.90 x 3.70 m
-  1.90 m
-  7.00 m³
-  13
- 

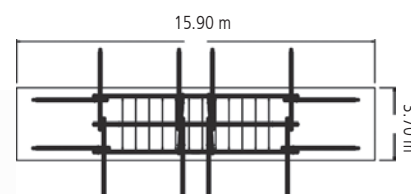

👍 The piece of equipment for the biggest stamped! Successfully used in schools and parks for many years now.

Please note!

The space required for foundations (assembly space) is bigger than the minimum space requirement for the equipment.

Separately as an attachment too (Rope-end swing incl. suspension Ropes and bearing) for your stand-alone designs.









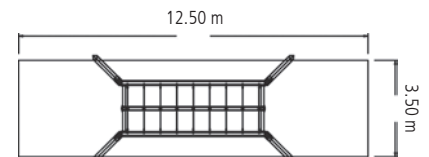

Victory Swinger

Art. No. 4585-50



For symbol explanation see folding card at the back



-  2.90 m
-  7.75 x 3.65 m
-  43.20 m²
-  12.50 x 3.50 m
-  1.75 m
-  1.60 m³
-  9
- 



Please note!
The space required for foundations (assembly space) is bigger than the minimum space requirement for the equipment.



Gondolar Swinger









Art. No. 4585S, with steel posts (Ø 102 mm)

Art. No. 4585PS, with wood posts (Ø 180 mm), with post shoes



Design here with Douglas fir posts

For symbol explanation see folding card at the back

-  2.80 m
-  3.75 x 2.20 m
-  24.90 m²
-  7.90 x 3.20 m
-  1.50 m
-  2.40 m³
-  4
- 

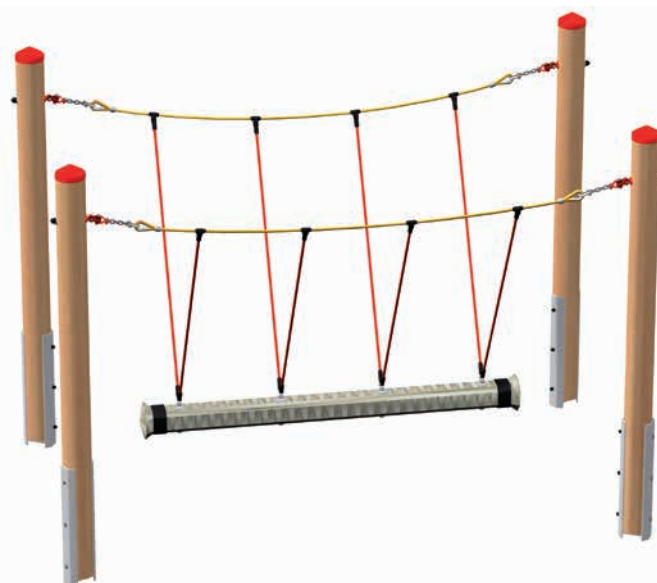
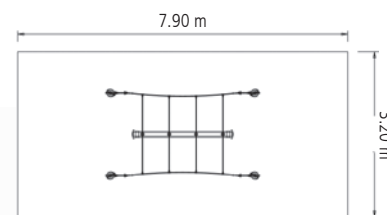











Cyclops Swinger, 4-seater, single

Art. No. 4585-MD4



For symbol explanation see folding card at the back

-  2.55 m
-  5.00 x 2.15 m
-  28.30 m²
-  8.85 x 3.20 m
-  1.50 m
-  0.90 m³
-  6
- 

Picture shows double version with 3 seats each,
Picture shows single version with 4 seats.
3 or 5 seats version also available upon request.

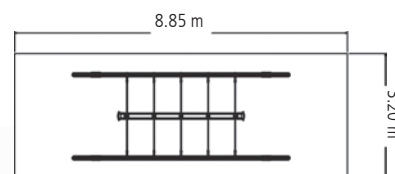









Hydra Swinger, 4-seater, double

Art. No. 4585-MDD4



For symbol explanation see folding card at the back

-  2.55 m
-  5.00 x 4.15 m
-  45.60 m²
-  8.85 x 5.20 m
-  1.50 m
-  1.30 m³
-  12
- 

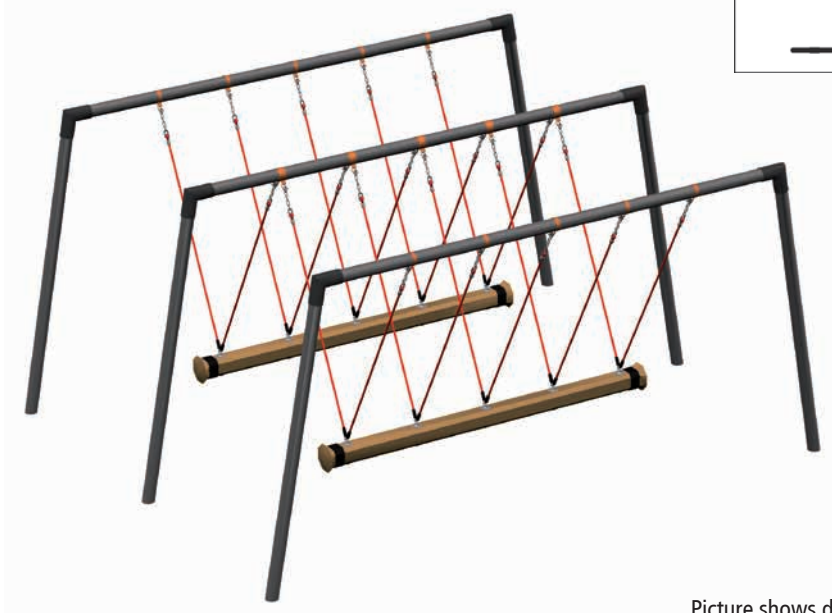
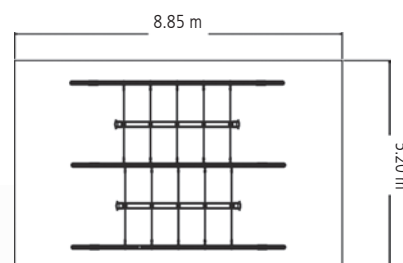

Picture shows double version, each with 4 seats.
Further designs with 3 or 5 seats on request!



**AMAZING
DISCOVERY**



PARCOURS

Simply combine to suit

Highly variable, easy to install, easy to maintain and suitable for children aged from 2-14 years. Create your own playground according to your individual needs and space. Depending on age group and requirements, you can choose between different post heights, rubber mats, hanging ropes, wobbly beams, climbing nets and much more. Each parcours is unique and adaptable to suit your specific environment.

The nets are made of Hercules rope; with proven HUCK quality. Basically, all parcours elements (including large playground equipment) can be combined with each other. Give us your desired combination, and we will happily advise on suitable design and fit. Lacking in space? No problem, we have the solution.

PRODUCT HIGHLIGHT

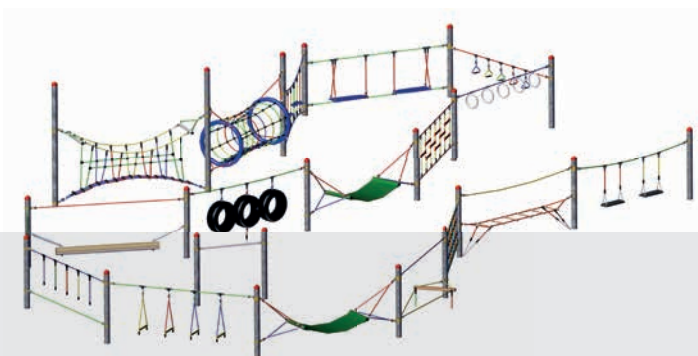

With a variety of course elements, you can create a bespoke playscape tailored to the needs of your community. The integration of barrier-free elements ensures that children of all abilities can play and learn together.



Possible Combinations

All individual elements (from page 118) can be combined with one another

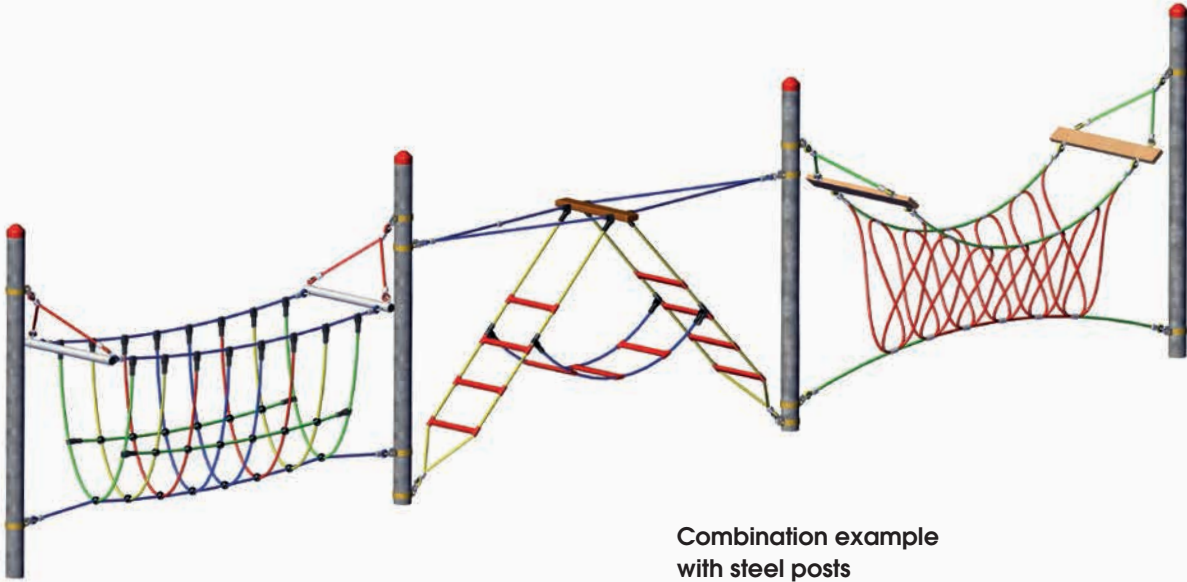

**Combination example
with steel posts**

Bridge "Fun-course"
3-Part Ladder "Fun-course"
Loop Bridge "Fun-course"

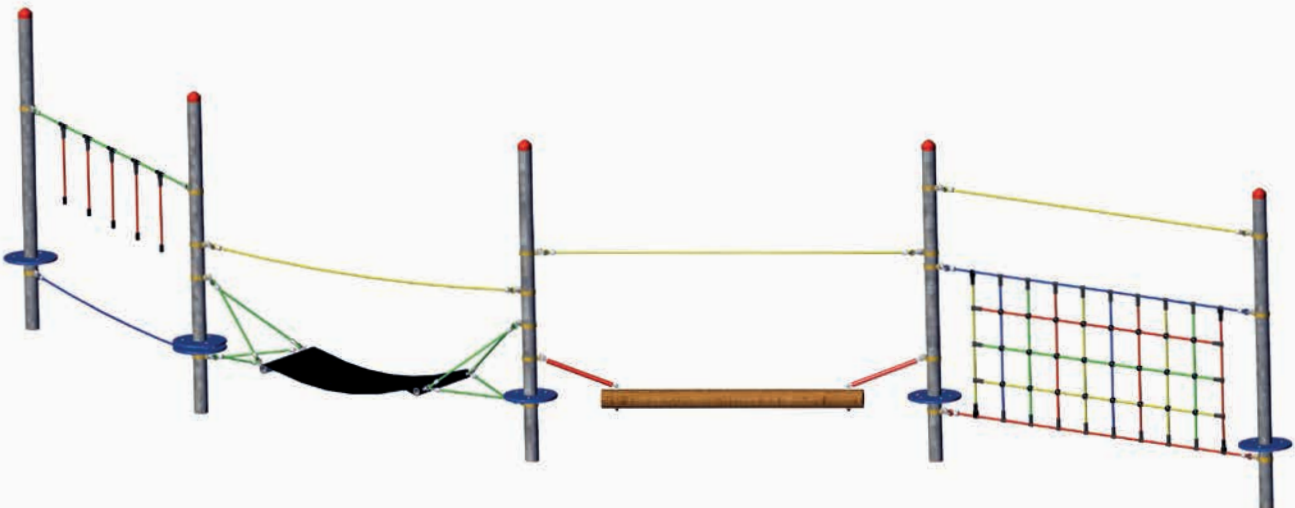

**Combination example
with steel posts**

Hanging Rope "Dillenburg"
Rubber Hammock "Dillenburg"
Wobble Beam "Dillenburg"
Climbing Net "Dillenburg"



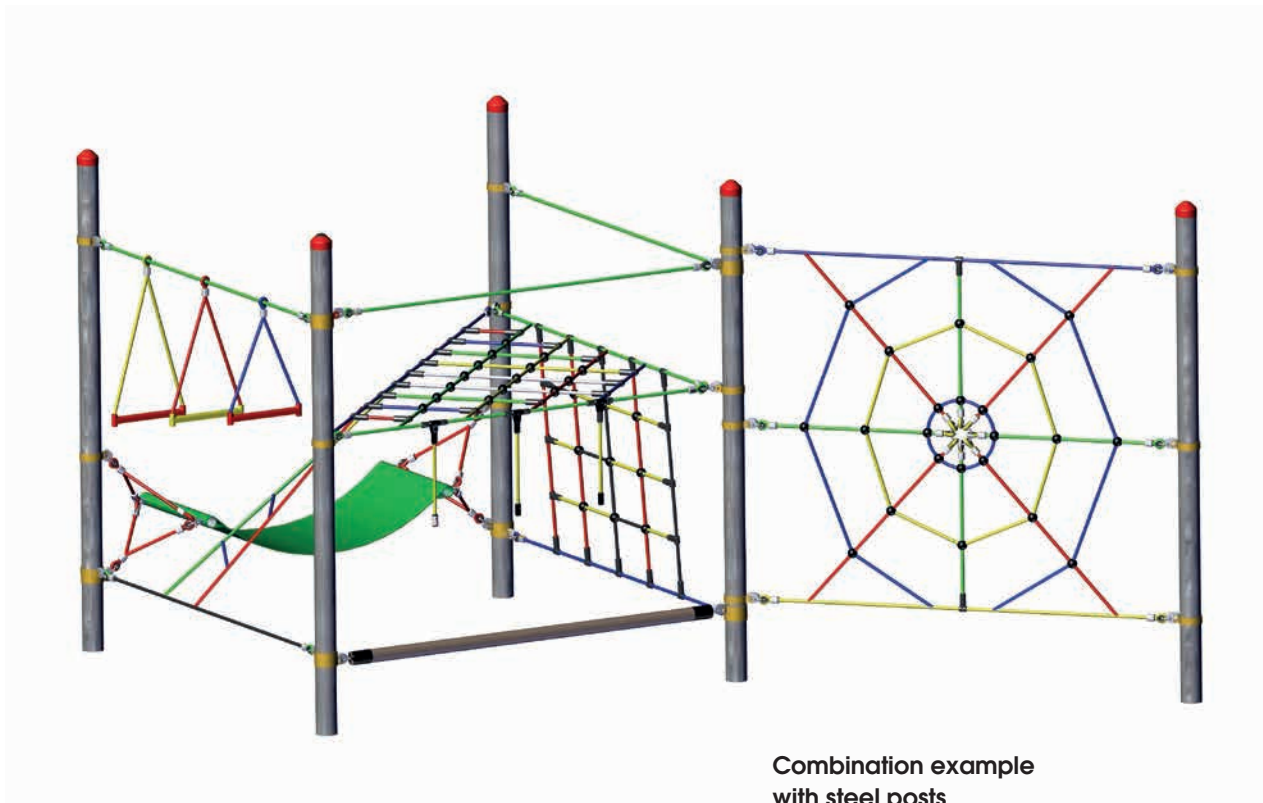

**Combination example
with steel posts**

Vario-Element 1
Vario-Element 2
Vario-Element 3

Vario-Element 4
Vario-Element 8

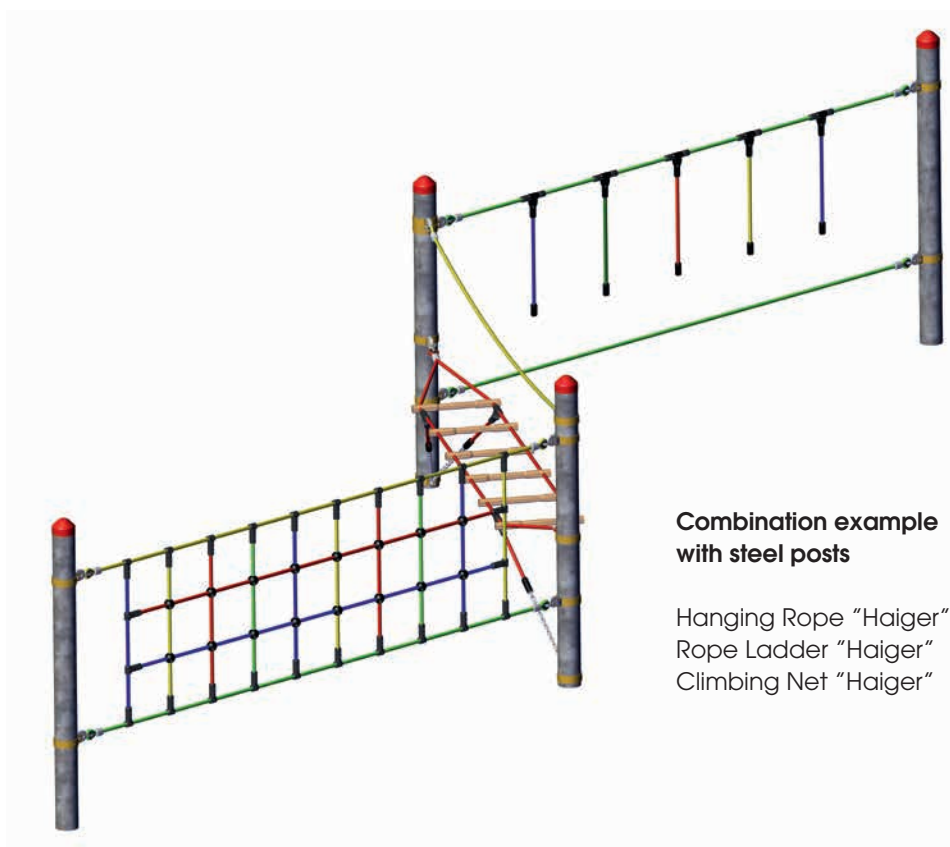

**Combination example
with steel posts**

Hanging Rope "Haiger"
Rope Ladder "Haiger"
Climbing Net "Haiger"



Individual Elements, post spacing of 3.00 m

Without support posts



Swing Seats
"Haiger"

Art. No. 4591-1 / Steel
Art. No. 4591-1-R / Robinia

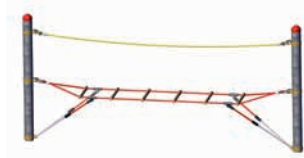

Rope Ladder
"Haiger"

Art. No. 4591-2 / Steel
Art. No. 4591-2-R / Robinia

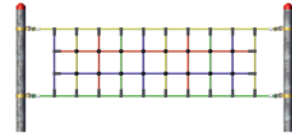

Climbing Net
"Haiger"

Art. No. 4591-3 / Steel
Art. No. 4591-3-R / Robinia

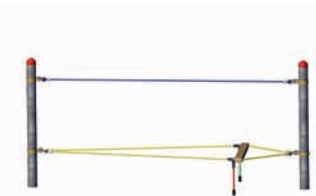

Balancing Rope
"Haiger"

Art. No. 4591-4 / Steel
Art. No. 4591-4-R / Robinia



Rubber Hammock
"Haiger"

Art. No. 4591-5 / Steel
Art. No. 4591-5-R / Robinia



Rope Ladder Rungs
"Haiger"

Art. No. 4591-6 / Steel
Art. No. 4591-6-R / Robinia



Arc Rope
"Haiger"

Art. No. 4591-7 / Steel
Art. No. 4591-7-R / Robinia

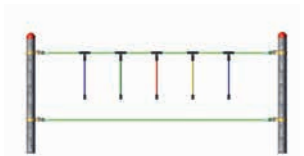

Hanging Rope
"Haiger"

Art. No. 4591-8 / Steel
Art. No. 4591-8-R / Robinia

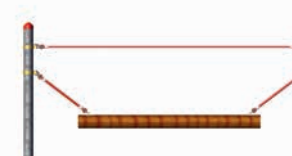

Wobble Beam
"Haiger"

Art. No. 4591-9 / Steel
Art. No. 4591-9-R / Robinia



Polyester Hammock
"Haiger"

Art. No. 4591-11 / Steel
Art. No. 4591-11-R / Robinia

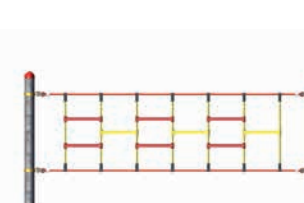

Climbing Rungs
"Haiger"

Art. No. 4591-12 / Steel
Art. No. 4591-12-R / Robinia



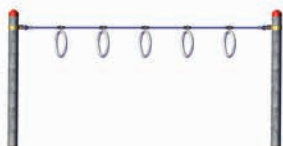

Holding Rings
"Haiger"

Art. No. 4591-13 / Steel
Art. No. 4591-13-R / Robinia



Holding Loops
"Haiger"

Art. No. 4591-14 / Steel
Art. No. 4591-14-R / Robinia

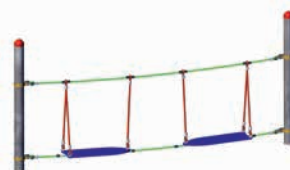

Surfer
"Haiger"

Art. No. 4591-15 / Steel
Art. No. 4591-15-R / Robinia

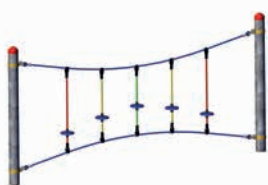

Small Disc
"Haiger"

Art. No. 4960-3 / Steel
Art. No. 4960-3-R / Robinia



Bar, single
"Haiger"

Art. No. 4960-9 / Steel

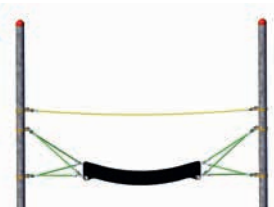

Rubber Hammock
"Dillenburg"

Art. No. 4591-60-5 / Steel
Art. No. 4591-60-5-R / Robinia

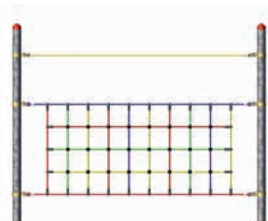

Climbing Net
"Dillenburg"

Art. No. 4591-60-3 / Steel
Art. No. 4591-60-3-R / Robinia

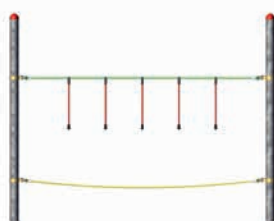

Hanging Rope
"Dillenburg"

Art. No. 4591-60-8 / Steel
Art. No. 4591-60-8-R / Robinia

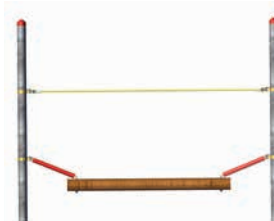

Wobble Beam
"Dillenburg"

Art. No. 4591-60-9 / Steel
Art. No. 4591-60-9-R / Robinia



Individual Elements, post spacing of 2.25 m

Without support posts

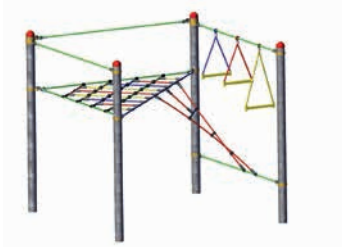

Vario-Element 1

Art. No. 4591-30-1 / Steel
Art. No. 4591-30-1-R / Robinia



Vario-Element 2

Art. No. 4591-30-2 / Steel
Art. No. 4591-30-2-R / Robinia



Vario-Element 3

Art. No. 4591-30-3 / Steel
Art. No. 4591-30-3-R / Robinia



Vario-Element 4

Art. No. 4591-30-4 / Steel
Art. No. 4591-30-4-R / Robinia



Vario-Element 5

Art. No. 4591-30-5 / Steel
Art. No. 4591-30-5-R / Robinia

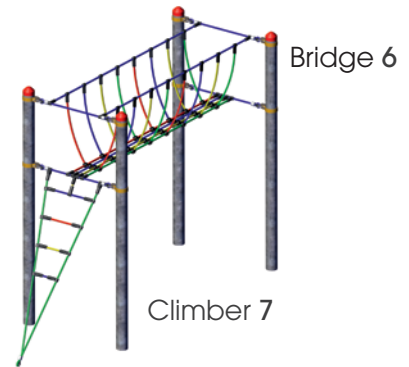

Vario-Element 6 + 7

Bridge 6:
Art. No. 4591-30-6 / Steel
Art. No. 4591-30-6-R / Robinia

Climber 7:
Art. No. 4591-30-7 / Steel
Art. No. 4591-30-7-R / Robinia

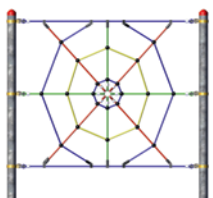

Vario-Element 8

Art. No. 4591-30-8 / Steel
Art. No. 4591-30-8-R / Robinia

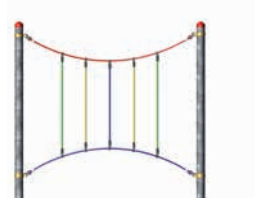

Vario-Element 9

Art. No. 4591-30-9 / Steel
Art. No. 4591-30-9-R / Robinia

Bridge 11

Slide 10

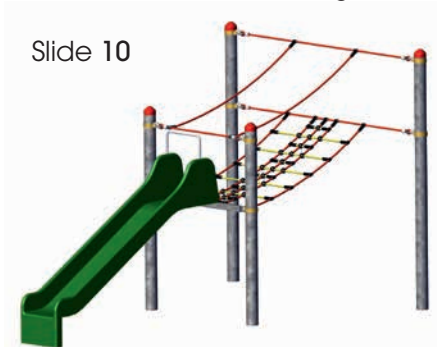

Vario-Element 10 + 11

Slide 10:

Art. No. 4591-30-10 / Steel

Art. No. 4591-30-10-R / Robinia

Bridge 11:

Art. No. 4591-30-11 / Steel

Art. No. 4591-30-11-R / Robinia



Vario-Element 12

Art. No. 4591-30-12 / Steel

Art. No. 4591-30-12-R / Robinia



Vario-Element 13

Art. No. 4591-30-13 / Steel

Art. No. 4591-30-13-R / Robinia



Vario-Element 14

Art. No. 4591-30-14 / Steel

Art. No. 4591-30-14-R / Robinia



Vario-Element 15

Art. No. 4591-30-15 / Steel

Art. No. 4591-30-15-R / Robinia



Vario-Element 16

Art. No. 4591-30-16 / Steel

Art. No. 4591-30-16-R / Robinia



Vario-Element 17

Art. No. 4591-30-17 / Steel

Art. No. 4591-30-17-R / Robinia

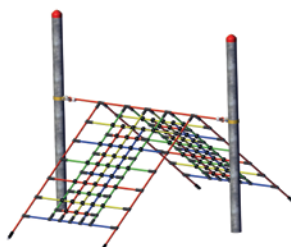

Vario-Element 19

Art. No. 4591-30-19 / Steel

Art. No. 4591-30-19-R / Robinia



Vario-Element 20

Art. No. 4591-30-20 / Steel

Art. No. 4591-30-20-R / Robinia





Individual Elements, post spacing of 3.00 m

Without support posts

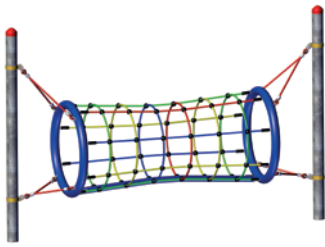

Adventure Tunnel
"Fun course"

Art. No. 4960-1 / Steel
Art. No. 4960-1-R / Robinia

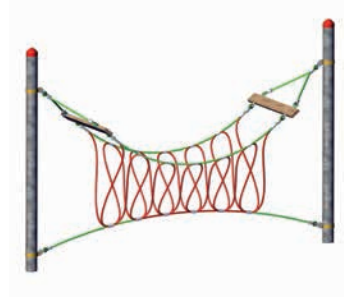

Loop Bridge
"Fun course"

Art. No. 4960-2 / Steel
Art. No. 4960-2-R / Robinia

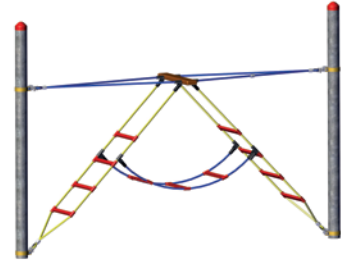

3-part Ladder
"Fun course"

Art. No. 4960-4 / Steel
Art. No. 4960-4-R / Robinia

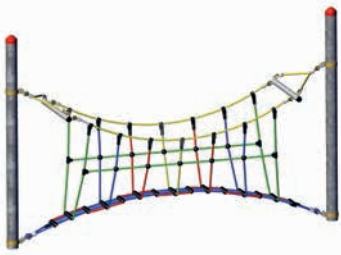

Arc Bridge
"Fun course"

Art. No. 4960-5 / Steel
Art. No. 4960-5-R / Robinia

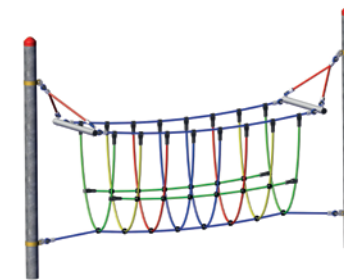

Bridge
"Fun course"

Art. No. 4960-6 / Steel
Art. No. 4960-6-R / Robinia

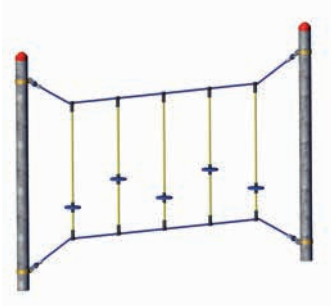

Small Discs
"Fun course"

Art. No. 4960-7 / Steel
Art. No. 4960-7-R / Robinia



Support posts in steel or robinia

Available individually / length of post based on element selected

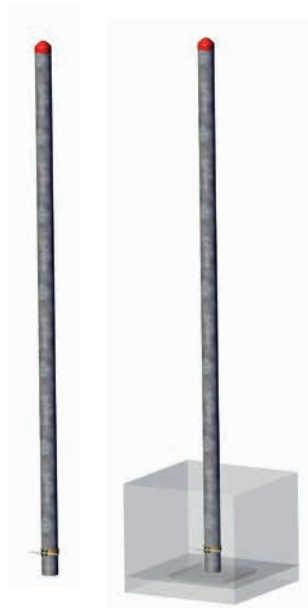

Steel posts

Ø 102 mm
hot-dip galvanised incl. red post cap

🔍 See page 14 for information on posts



Robinia posts

Ø 160 - 200 mm
incl. steel shoes

Length 2.40 m

"Haiger"-Element / Art. No. 4591-0

Length 2.30 m

"Haiger"-Element / Art. No. 4591-0-R

Length 3.00 m

"Fun course"-Element / Art. No. 4960-0

Length 2.90 m

"Fun course"-Element / Art. No. 4960-0-R

Length 3.40 m

"Vario" and "Dillenburg"-Elements
Art. No. 4591-30-0

Length 3.40 m

"Vario" and "Dillenburg"-Elements
Art. No. 4591-30-0-R

Foot plate for all steel posts

Art. No. 4591-60-S
Height adjustable

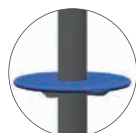

Foot plate for all Robinia posts

Art. No. 4575-S
Height must be specified
when ordering



- ⊕ Steel posts are available Powder-Coated on request
- ⊕ Most RAL colours are available



BE STRONG!



CLIMBING NETS AND BRIDGES

The positive influence of climbing is undisputed. For children this activity could result in their motor skills being trained, improved and reinforced. Our nets stimulate children to face these experiences and at the same time still provides for maximum safety.

Creativity knows no bounds thanks to our vast selection: we offer you different colours, lengths and materials so that the bridges, nets, ropes and ladders completely match your wishes and expectations.

PRODUCT HIGHLIGHT

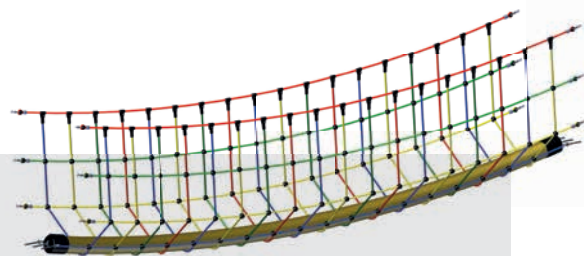

Keeping your balance on this playful bridge strengthens your sense of balance and contributes to the development of coordination and self-confidence.



Jungle Bridge
Page 137



High-quality connectors for our Hercules ropes



HUCK plastic knot system

In use worldwide for decades, our HUCK plastic knot ball with a diameter of 48 mm connects a wide variety of nets and ropes. Whether simple climbing nets or large net landscapes in various shapes and sizes - the HUCK knot ball offers a reliable and durable connection (also available in 2 parts for repair purposes)

- ✔ Round form without corners and edges for pleasant tactile feel
 - ✔ Can be easily replaced
 - ✔ Colour options in beige and black
- And new additions in blue, yellow, red**



HUCK aluminium knot system

For special applications, HUCK also offers aluminum knot balls with a diameter of 28 mm (for HUCK Hercules rope Ø 18)

- ✔ High transmission of force between ropes
- ✔ Round form without corners and edges for pleasant tactile feel



HUCK Stainless-steel clips

These connectors, which are suitable for horizontal nets, are particularly characterized by their high-quality material and clear design.

- ✔ high-quality design, matches a wide variety of rope colors
- ✔ comfortable to lie down and relax
- ✔ made of stainless steel V2A



HUCK Cross-stitch connector

Executed in a cross-stitch design for Hercules ropes, we use this knot connector at the customer's request to put the rope in the foreground. Particularly popular for horizontal nets – e.g. hammocks.

- ✔ Colour options: blue, black, red, beige
- ✔ pleasant for laying on and relaxing
- ✔ rope in the foreground





Climbing Nets / PP-Rope

PP-Climbing Nets with braided knots

Art. No.	Description	Mesh size in mm
4116-110	PP, Ø 16 mm	110
4116-250	PP, Ø 16 mm	250
4116-300	PP, Ø 16 mm	300
4116-400	PP, Ø 16 mm	400
4116-500	PP, Ø 16 mm	500
4120-250	PP, Ø 20 mm	250
4120-300	PP, Ø 20 mm	300
4120-400	PP, Ø 20 mm	400
4120-500	PP, Ø 20 mm	500
4125-250	PP, Ø 25 mm	250
4125-300	PP, Ø 25 mm	300



⊕ Low-cost Alternative

16 mm in diameter but no steel core, our PP rope is more reasonable than the Hercules rope and is brilliantly perfect for the indoor area.

⊕ Flexible Connector

Braided knots, not only look great, but also make the rope flexible.

⊕ Colour options

The 4-shaft rope made from PP multi-strand is available in the following colours: black, beige, orange, green and blue.





Climbing Nets made from Hercules rope

Hercules-Climbing Nets

made from Ø 16 mm Hercules rope, six-strand, with knot ball system

Art. No.	Description	Mesh size in mm
4316-120	Hercules, Ø 16 mm	120
4316-250	Hercules, Ø 16 mm	250
4316-300	Hercules, Ø 16 mm	300
4316-350	Hercules, Ø 16 mm	350
4316-400	Hercules, Ø 16 mm	400
4316-500	Hercules, Ø 16 mm	500

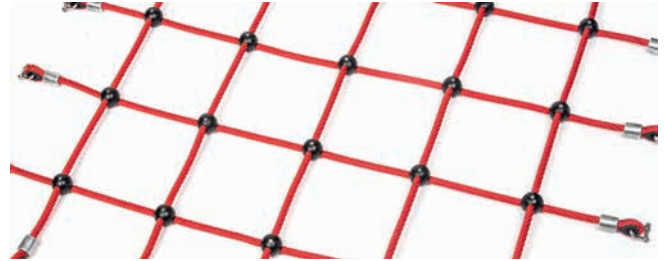

Hercules-Climbing Nets

made from Ø 18 mm Hercules rope, six-strand, with aluminium knot ball system

Art. No.	Description	Mesh size in mm
4618-120	Hercules, Ø 18 mm	120
4618-250	Hercules, Ø 18 mm	250
4618-300	Hercules, Ø 18 mm	300
4618-350	Hercules, Ø 18 mm	350
4618-400	Hercules, Ø 18 mm	400
4618-500	Hercules, Ø 18 mm	500

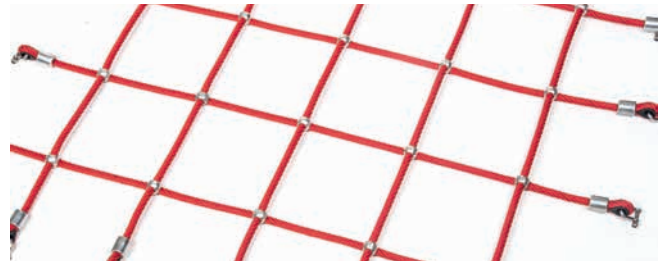

Hercules-Climbing Nets

made from Ø 16 mm Hercules rope, six stranded, with stainless steel clips

Art. No.	Description	Mesh size in mm
4516-120	Hercules, Ø 16 mm	120
4516-250	Hercules, Ø 16 mm	250
4516-300	Hercules, Ø 16 mm	300
4516-350	Hercules, Ø 16 mm	350
4516-400	Hercules, Ø 16 mm	400
4516-500	Hercules, Ø 16 mm	500

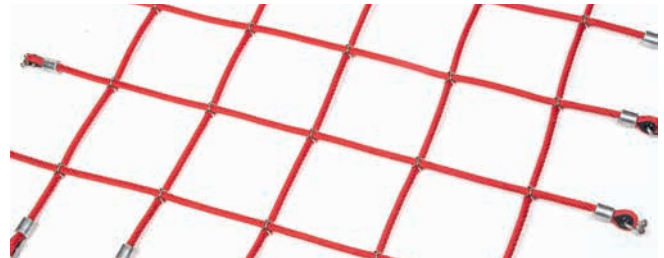

Hercules-Climbing Nets

made from Ø 16 mm Hercules rope, four-stranded, with cross-stitch connection

Art. No.	Description	Mesh size in mm
4416-120	Hercules, Ø 16 mm	120
4416-250	Hercules, Ø 16 mm	250
4416-300	Hercules, Ø 16 mm	300
4416-400	Hercules, Ø 16 mm	400
4416-500	Hercules, Ø 16 mm	500

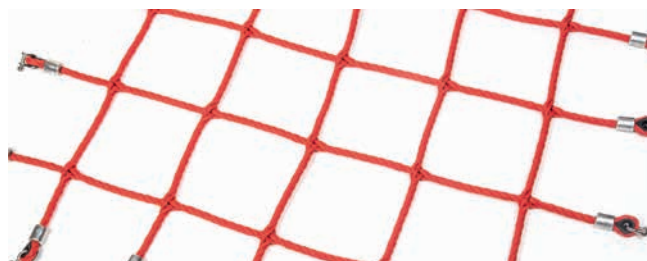

IMPORTANT. PLEASE SPECIFY WHEN ORDERING:

- 1 lightweight frame dimensions
- 2 intended attachment side
- 3 fastening devices
- 4 Length of fastener required (thread lengths)
- 5 Rope colour (Page 11)

Smaller size supplements for climbing nets
 under 1 m² + 50 %
 under 2 m² + 25 %

The HUCK Hercules quality:

- ⊕ Each rope consists of six steel strands coated with polyester
- ⊕ Quality assurance through several test methods
- ⊕ High colour, UV and abrasion resistance

Adventure made in Germany
HUCK PLAY EQUIPMENT

Production of all ropes in Asslar, Berghausen, Germany.



Exemplary mounting options for climbing nets, climbing ropes, bridges, etc.

We have developed many, well-thought out and practical solutions, facilitating the attachment of our ropes to the most varied of elements. You will find a small selection below; please do not hesitate to contact our contact persons for further information on special solutions.

Please note that these elements are designed exclusively for use with our Hercules rope. Unfortunately, it is not possible to buy single elements.

Net edging connectors + Now in new slim design



Plastic T-connectors



Plastic T joint



Plastic T-joint available in blue, beige, red, black and yellow.

Attachment to posts and beams

Bolt lengths freely selectable / bolts in stainless steel as standard



Eyebolt stainless steel
Art. No. 455B
M8/M10/M12 with threaded end



Threaded bolt, stainless steel
Art. No. 454V
M8/M10/M12



Threaded bolt, stainless steel
Art. No. 454
M10/M12 with threaded end



Eyebolt stainless steel
Art. No. 455-M10
Art. No. 455-M12



Rope Loop
Art. No. 464
Inner diameter freely selectable



Thimble stainless steel
Art. No. 457VA
Inner diameter 35 mm



Plastic round thimble
Art. No. 457R
Black, inner diameter 35 mm



Steel ring, galvanized
Art. No. 453
M8 x 40 mm, M10 x 50 mm,
M10 x 60 mm



Chain 6 mm
Art. No. 461V
Galvanized, (short links)
direct crimped



Chain 6 mm
Art. No. 461
Galvanized, (short links)
Incl. plastic adaptor



Chain shackle, stainless steel
Art. No. 440-30
For 6 mm or 8 mm chain,
(short links)



Shackle stainless steel
Art. No. 440-8G
M8 (cambered), crimped



Further stainless steel fixings and connectors



Chain adapter M12, stainless steel
Art. No. 461-6
including threaded bolts,
for connection with 6 mm chain



Chain adapter M16, stainless steel
Art. No. 461-8
including threaded bolts,
for connection with 8 mm chain



Chain shackle M6, stainless steel
Art. No. 440-6-3
3 split connector for 6 mm chain



Chain shackle M6 stainless steel
Art. No. 440-6-4
4 split connector for 6mm chain



Bearing connector, stainless steel
Art. No. 430
For shackle M8 oder M10
Also 2 or 3 eyelet shackle
M16 or M12 threaded bolt



**Bearing connector, stainless steel
with threaded bolt**
Art. No. 443
For shackle M8 or M10
Also 2 or 3 eyelet shackle on M12
threaded bolt (inner thread)



Sleeve nut M12 stainless steel
Art. No. 433
with torx drive and inner thread M12





Thimble chain sprocket stainless steel

Art. No. 4603-20

swivel with with wear-resistant bronze bearing
for maximum torc load of 6 mm or 8 mm chain on
Hercules rope Ø 16 mm



Thimble swivel, stainless steel

Art. No. 4603-10

swivel ring with wear-resistant bronze bearing
from VA anchor or bearing
Art. No. 4602 on Hercules rope Ø 16 mm



2-eyelet shackle, stainless steel

incl. cross bolt M10

Art. No. 440-10

without bearing, ideal for corner formation with horizontal
nets, for Hercules rope Ø 16 mm or Ø 18 mm, also available
as a 3-eyelet shackle, incl. cross bolt M8



3-eyelet shackle made of stainless steel

incl. cross bolt M10

Art. No. 440-20

ideal for forming corners in horizontal nets,
for Hercules rope Ø 16 mm or 18 mm on chain 6 mm,
8 mm or VA anchor, incl. cross bolt M8



➕ Further fixings available
on our website. Allow us to help you!



Climbing ropes

Please observe the requirements of DIN EN 1176-1 Para. 4.2.12 when using climbing ropes: For ropes with an attachment on one side (Length up to 2.00 m) the distance to the next fixed piece of equipment must be 60 cm. For rope lengths between 2.00m and 4.00 m this distance can be increased to 1.00 m The lengths specified are standard lengths, other lengths can be requested.



Art. No. 480



Art. No. 481



Art. No. 38250

PP-Climbing rope

Art. No.	Product description	Diameter	Rope colour	Length	Top attachment	Bottom attachment
480	PP-Climbing rope	24 mm	orange, blue, hemp coloured	2.00 m	Thimble and ring 10 x 50 mm, galvanized	1 x knot + plastic end cap
481	PP-Climbing rope with knots	24 mm	orange, blue, hemp coloured	2.00 m	Thimble and ring 10 x 50 mm, galvanized	Plastic-end cap
38250	PP-Climbing rope	33 mm	hemp coloured	2.50 m	Galvanized rope holder	Plastic sleeve



Art. No. 479 | 482



Art. No. 483



Art. No. 484

Hercules Climbing rope

Art. No.	Product description	Diameter	Rope colour	Length	Top attachment	Bottom attachment
479	Hercules Climbing rope	16 mm	green, orange, blue, yellow, fluorescent orange, black, grey, red, hemp coloured, rust	2.00 m	Thimble and ring 10 x 50 mm, galvanized	Plastic-end cap
482	Hercules Climbing rope	18 mm	green, blue, yellow, black, red, hemp coloured	2.00 m	Thimble and ring 10 x 50 mm, galvanized	Plastic-end cap
483	Hercules Climbing rope with climbing aid*	18 mm	green, blue, yellow, black, red, hemp coloured	2.00 m	Thimble and ring 10 x 50 mm, galvanized	Plastic-end cap
484	Hercules Climbing rope	25 mm	blue, yellow, red, hemp coloured	2.00 m	Thimble and ring 10 x 50 mm, galvanized	Plastic-end cap

*Colours of climbing aids: yellow, red, black or hemp coloured

Double-sided connections for climbing ropes



Supplement for bottom attachment
Art. No. 4825



Example (without ground anchor screw):
6 mm galvanised chain, length approx. 40 cm (in the ground) or ring bolts on both rope ends or other fastening options (pages 130-132).



Ground anchor (screwable)
Art. No. 410

Steel (Ø ca. 10 mm), hot-dip galvanized
Length approx. 40 cm



Loops/Rings



Art. No. 403



Art. No. 404

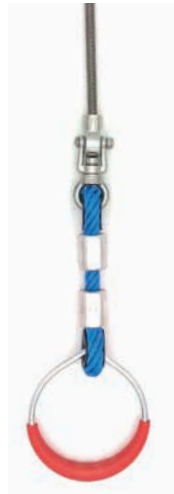

Art. No. 404K



Art. No. 404-1



Art. No. 474



Art. No. 4741

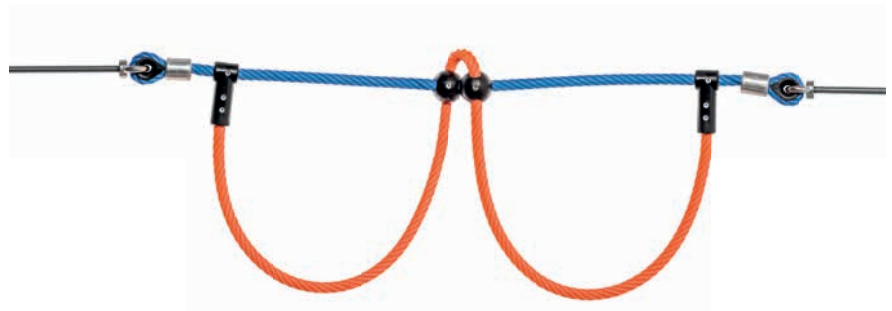

Art. No. 489-10

Art. No.	Product description	Rope colours	Design
403	Roman ring		Without rope and chain
404	Roman ring with Hercules rope	green, orange, fluorescent orange, blue, yellow, black, grey, red, hemp coloured, turquoise, fuchsia	20 cm Hercules rope and rings screw M12 x 200 mm
404K	Roman ring with Hercules rope & thimble swivel	green, orange, fluorescent orange, blue, yellow, black, grey, red, hemp coloured, turquoise, fuchsia	20 cm Hercules rope and Thimble swivel + VA bearing adapter M12 x 200mm
404-1	Roman ring with chain		20 cm chain 6 mm vz. and Eyebolt M12 x 200mm
474	Polyester gym ring (Outside) Ø 290 mm		Without rope and chain
4741	Polyester gym ring 28 x 240 mm with 16 mm Ø – Hercules rope	green, orange, fluorescent orange, blue, yellow, black, grey, red, hemp coloured, turquoise, fuchsia	50 cm Hercules rope and 40 cm 6 mm vz chain
489-10	Garland rope with 16 mm Ø – Hercules rope	green, orange, fluorescent orange, blue, yellow, black, grey, red, hemp coloured, turquoise, fuchsia	both rope ends with Eyebolt M12 x 200 mm Stand length 3.00 m

On request, the versions can be selected individually (e.g. lengths, fixtures).





Ladders

Our rope ladders are designed and developed to be used on playground area, the maximal load per ladder is 150 kg. They are not to be used as a rescue ladder or in the industrial area with the corresponding extensions. The distance between the rungs is 30 cm, the ladder width is approx.

40 cm. The recommended ground clearance to the lowest rung is 40 cm. The ladder length ordered is always measured from top suspension point to the lowest rung.



Art. No. 40

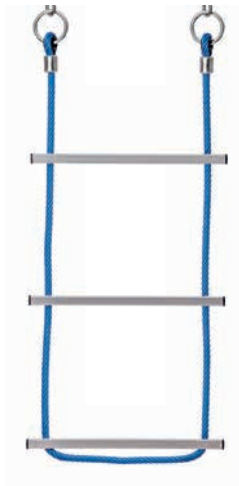

Art. No. 42



Art. No. 44

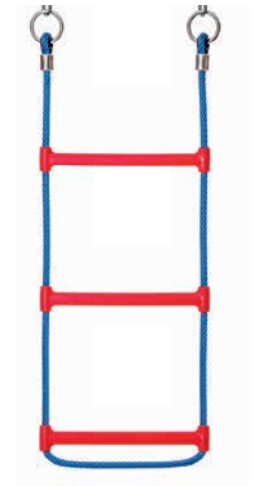

Art. No. 44-10

Art. No.	Rungs	Rope suspension	Rope colours	Design
40	Acacia wood	PP-Multi strand rope, Ø 16 mm	Orange, blue, hemp coloured, black, green (new)	Both top rope ends with thimble and ring 10 x 50 mm, galvanized
42	Aluminium	Hercules rope, Ø 16 mm	green, orange, fluorescent orange, blue, yellow, black, grey, red, hemp coloured, turquoise, fuchsia	Both top rope ends with thimble and ring 10 x 50 mm, galvanized
44	Acacia wood	Hercules rope, Ø 16 mm	green, orange, fluorescent orange, blue, yellow, black, grey, red, hemp coloured, turquoise, fuchsia	Both top rope ends with thimble and ring 10 x 50 mm, galvanized
44-10	Plastic	Hercules rope, Ø 16 mm	green, orange, fluorescent orange, blue, yellow, black, grey, red, hemp coloured, turquoise, fuchsia	Both top rope ends with thimble and ring 10 x 50 mm, galvanized

Possible Ladder fixings



1 point fixing



2 point fixing

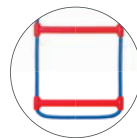

Without fixing (standard)

Supplement for bottom attachment
Art. No. 4826

Examples (without ground anchor screw)
6 mm galvanized chain, length approx. 40 cm (in the ground)
or 1x or 2x ground anchor chain
or other mounting options (page 130-132).



Ground anchor (screwable)
Art. No. 410

Steel (Ø ca. 10 mm), hot-dip galvanized
Length approx. 40 cm



Net bridge
in V-Form, per running m.
Art. No. 4957-300

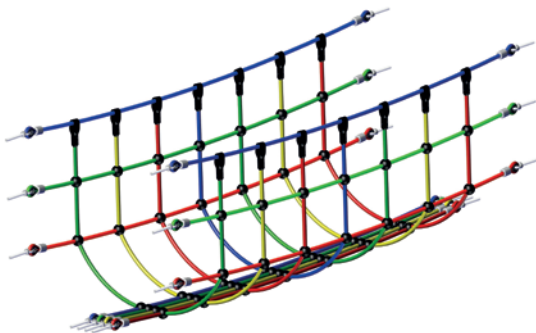

Net handrails
For wooden or rubber walkway,
per running metre
Art. No. 4910-300 Mesh size 30 x 25 cm



Simple Net Bridge
per running metre
Art. No. 4959-250

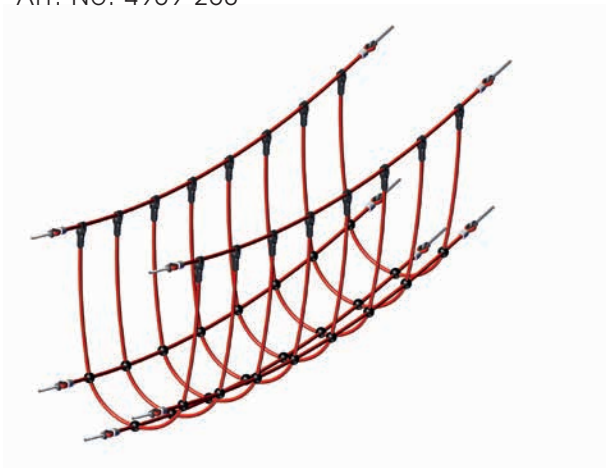

Net bridge
With additional wooden rungs,
per running metre
Art. No. 4952

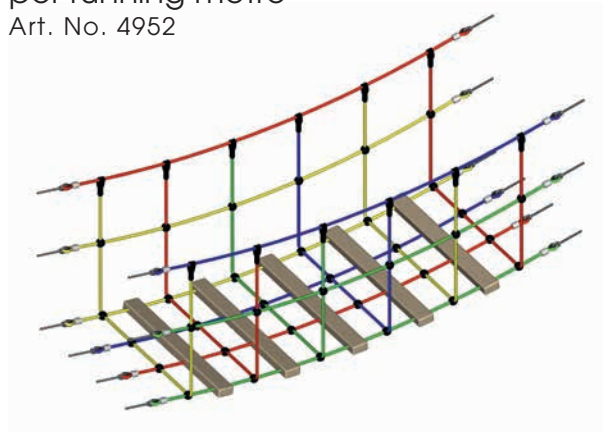

The illustrations are examples of standard bridges. Individual customization is possible.

Art. No.	Product description	Walkway	MW Walkway	Handrail height	MW handrail	Handrail width	Nominal width Footbridge	Attachments
4957-300	Net bridge in V-Form	4 x Hercules rope	3 x 5 cm	85 cm	30 x 30 cm	80 cm	18 cm	Eyebolt M12, Stainless steel
4910-300	Net handrails, both sides			85 cm	25 x 30 cm			Eyebolt M12, Stainless steel
4959-250	Simple Net Bridge	Hercules mesh	30 x 30 cm	80 cm	30 x 80 cm	60 cm	60 cm	Eyebolt M12, Stainless steel
4952	Net bridge with wooden rungs	Hercules – mesh and wooden rungs	27 x 30 cm	80 cm	40 x 60 cm	80 cm	80 cm	Eyebolt M12, Stainless steel

Standard items available up to 5.00 m in length, other lengths on request

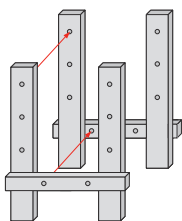

Outer cross beams
(underfoot material longer than handrail rope)

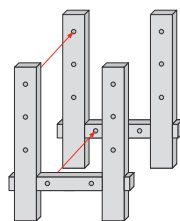

flush cross beams
(all ropes in equal lengths)

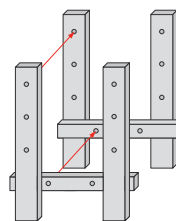

Inside cross beams
(underfoot material shorter than handrail rope)

When placing an order please give us the following details:

- clear opening between existing frames (Bridge length)
- dimension between axes/centre to centre of posts (Bridge width)
- desired bolt lengths of eyebolts
- Position of crossbeams to attach the underfoot material to
- Height variation between cross beams

Wooden Walkway

per running metre

Art. No. 4930-005-050 Nominal width 50 cm

Art. No. 4930-005-075 Nominal width 75 cm

Art. No. 4930-005-100 Nominal width 100 cm



Rubber Walkway

per running metre

Art. No. 4950

Nominal width 55 cm, Length max. 3.00 m

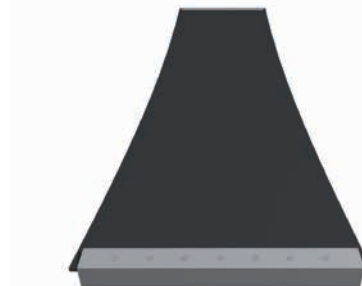

Jungle Bridge

per running metre

Art. No. 4954-300

with PP rope, beige, approx 90/90 mm

Art. No. 4956-300

With PP running rope, beige, approx 160/160 mm, length up to 5.00 m

New colours available: blue, green, black

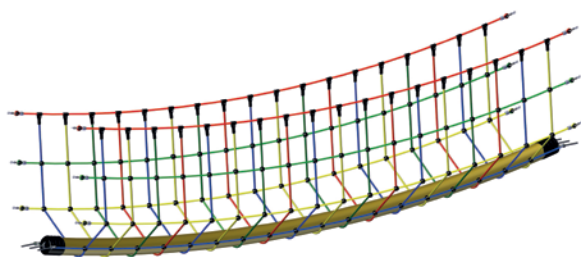

PP-Walkway rope

per running metre

Art. No. 4325-0090-08 walkway: 90/90 mm

Possible colours: beige

Art. No. 4325-0160-08 walkway: 160/160 mm,

Possible colours: beige

(no colour choice available with either product)



All running ropes with comfortable square cross section

"plus" fixings at both end of each running rope

Art. No. 495 e.g. Ring screw

Art. No.	Product description	Walkway	Handrail height	MW Handrail	Handrail width	Nominal walkway	Attachments
4930-005-050	Wooden Walkway, 50 cm Nominal width	Larch rungs, 45 x 95 mm				50 cm	Eyebolt M12, Stainless steel
4930-005-075	Wooden Walkway, 75 cm Nominal width	Larch rungs, 45 x 95 mm				75 cm	Eyebolt M12, Stainless steel
4930-005-100	Wooden Walkway, 100 cm Nominal width	Larch rungs, 45 x 95 mm				100 cm	Eyebolt M12, Stainless steel
4950	Rubber Walkway 55 cm Nominal width	Closed rubber base				55 cm	Extended ends
4954-300	Jungle Bridge	90/90 mm PP-Walkway rope	85 cm	30x30 cm	85 cm	9 cm	Eyebolt M12 / M16, Stainless steel
4956-300	Jungle Bridge	160/160 mm PP-Walkway rope	85 cm	30x30 cm	85 cm	16 cm	Eyebolt M12 / M16, Stainless steel
4325-0090-08 + 495	PP-Walkway rope	90/90 mm				9 cm	Eyebolt M12/M16, Stainless steel (Art. No. 495)
4325-0160-08 + 495	PP-Walkway rope	160/160 mm				16 cm	Eyebolt M12/M16, Stainless steel (Art. No. 495)

Standard items available up to 5.00 m in length, other lengths on request



HUCK Net Tunnel

Our net tunnels come in the most varied of forms and designs: round, square or triangular as add-ons to existing rope structures or as complete special structure in overlengths.

Hercules mesh is used for the covering, larch wooden rungs for the walkway or a rubber band or PP walking ropes available in different colours. Ring us and let us advise you!

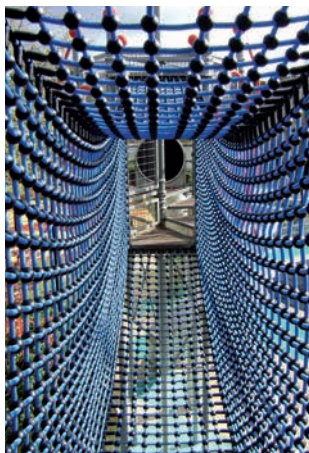

Net tunnel, square, underfoot material Hercules mesh



Net tunnel, round, underfoot material made from Hercules mesh incl. rope-wrapped steel ring



Net tunnel, square, underfoot material made from larch wooden rungs



Net tunnel, triangular, walkway made from PP walking rope

Art. No.	Product description	Walkway	MW walkway	Width	MW Handrail	Height	Attachments
4970	Net Tunnel	Hercules mesh	125 x 125 mm	75 cm	30 x 30 cm	90 cm	Eyebolt M12, Stainless steel
4971	Net Tunnel	Hercules mesh	125 x 125 mm	75 cm	30 x 30 cm	120 cm	Eyebolt M12, Stainless steel
4972	Net Tunnel	Hercules mesh	125 x 125 mm	90 cm	30 x 30 cm	90 cm	Eyebolt M12, Stainless steel
4973	Net Tunnel	Hercules mesh	125 x 125 mm	90 cm	30 x 30 cm	120 cm	Eyebolt M12, Stainless steel

Standard items available up to 5.00 m, other lengths on request



HUCK climbing chimney

Our climbing chimneys are also available in the most varied of forms and designs. Round and square, complete with small mesh size, with rope-wrapped ring for stabilisation and so on. Let us design, develop

and produce your individual climbing chimney. Give us a call and let us advise you!





Net bridges and net tunnels made to order

We deliver the individual bridges/tunnels in the appropriate lengths with access components, foundation or reinforcement designs and assembly instructions. We can include assembly if you so wish!

We fit the net bridges with a variety of underfoot materials and connection components.

The length of the bridge is based on the gap you want it to span, plus the required distance from the water's edge to the access point (approx. 1.50 m). Individual connection and construction parts are either decided by according to the bridge/tunnel type or are adapted to existing suspension builds following in-depth discussion with you.

When you order, please refer to the measurements given in the sketch where possible (a to f). With the help of this information we build a bridge/tunnel that conforms to EN 1176 (playground area; max. feet height 3.00 m with appropriate fall protection) or DIN 1055/1072 for public constructions.

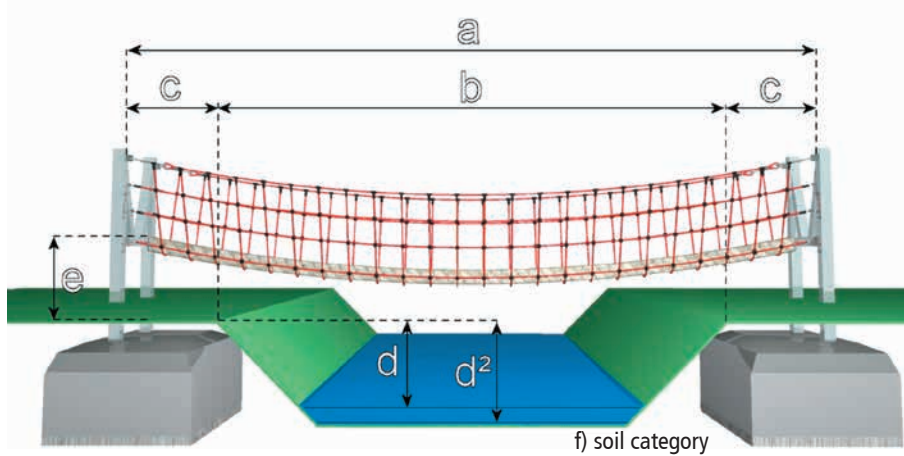

Details required for your order:

- a) clear measurement between the frame or the tower builds (if it exists already)
- b) measurement between any existing embankment edges
- c) measurement between the embankment edge and any existing frames
- d) measurement from the top edge of the play level to any existing water surface
- d²) measurement from the top of the play level to the lowest point on the ground
- e) preferred or existing access height
- f) soil category number (if known)

Installed HUCK – Bridges/tunnel complete solutions



Wooden walkway bridge, Length 54 m



Wooden walkway tunnel, Length 40 m



Net tunnel with suspended walkway rungs, Length 8 m



Wooden walkway bridge, Length 40 m



Jungle bridge in V-Form, Length 20 m



Net tunnel in V-Form (Swimming pool area), Length 21 m



**HIGHER
FURTHER!**

The classic among the swings is without a doubt the Original HUCK Bird's Nest which has stood testimony to safe play for almost thirty years. HUCK swings are suitable for all age groups and can be combined in a multitude of ways, providing big and small with pure enjoyment during play. In addition, we offer many models for people with disabilities, because inclusion in nurseries, schools and on playgrounds is a matter of the heart for us and shall be stipulated in new planning by the legislator.

PRODUCT HIGHLIGHT

The colourful link mats not only brings colour to the playground, but also encourage children's visual stimulation and creativity as they play and swing on them.



New coloured link mat for all bird nests.











Swing Frame "Twin", douglas fir

Art. No. 4577-3-250, without fixings or attachments



For symbol explanation see folding card at the back

Suspension height: 2.50 m

-  2.75 m
-  6.80 x 3.50 m
-  33.00 m²
-  7.60 x 5.35 m
-  1.45 m (swing seat)
-  1.55 m (Bird's Nest)
-  4.00 m³
-  01 = 12 / 02 = 2 / 03 = 7
- 

Please note!
The space required for foundations (assembly space) is bigger than the minimum space requirement for the equipment.

Our Original HUCK Bird's Nest can be found on Page 146!



You can find suitable hanging parts on pages 148, 149 and from page 152!

Combination examples:
Bird's Nest + Bird's Nest
Bird's Nest + rocking chair
Bird's Nest + 2x swing seat

Many other combinations possible



Arch Swing to set in concrete









Art. No. 4580-4B, incl. fixings, without attachments



For symbol explanation see folding card at the back

Our Original HUCK Bird's Nest can be found on Page 146!

Suspension height: 2.50 m

-  3.10 m
-  Ø 1.25 m
-  18.45 m²
-  7.40 x 2.50 m
-  1.50 m
-  2.25 m³
-  6
- 



On request, the Arc swing can be painted or powder coated for an additional cost

Please note!
The space required for foundations (assembly space) is bigger than the minimum space requirement for the equipment.



Swing Frame douglas fir

Art. No. 4577-1-200 Suspension height 2.00 m, without attachments and bearings









Art. No. 4577-1-250 Suspension height 2.50 m, without attachments and bearings











For symbol explanation see folding card at the back

Our Original HUCK Bird's Nest can be found on Page 146!

Suspension height: 2.00 m

-  2.25 m
-  4.15 x 2.60 m
-  16.80 m²
-  6.75 x 2.50 m
-  1.20 m (single seat)
1.30 m (Bird's Nest)
-  2.00 m³
-  6
- 

Suspension height: 2.50 m

-  2.75 m
-  4.15 x 3.00 m
-  18.90 m²
-  7.60 x 2.50 m
-  1.45 m (single seat)
1.55 m (Bird's Nest)
-  2.00 m³
-  6
- 

Please note!

The space required for foundations (assembly space) is bigger than the minimum space requirement for the equipment.



Swing Frame douglas fir, long

Art. No. 4577-2-200 Suspension height: 2.00 m, without attachments and bearings

Art. No. 4577-2-250 Suspension height: 2.50 m, without attachments and bearings





For symbol explanation see folding card at the back

You can find suitable hanging parts on pages 148, 149 and from page 152!

Suspension height: 2.00 m

-  2.25 m
-  7.15 x 2.60 m
-  41.00 m³
-  9.05 x 7.20 m
(varies depending on attachment)
-  1.20 m (single seat)
-  1.30 m (Bird's Nest)
-  2.00 m³
-  8
- 

Suspension height: 2.50 m

-  2.75 m
-  7.15 x 3.00 m
-  44.00 m³
-  9.05 x 8.00 m
(varies depending on attachment)
-  1.45 m (single seat)
-  1.55 m (Bird's Nest)
-  2.00 m³
-  8
- 

Please note!

The space required for foundations (assembly space) is bigger than the minimum space requirement for the equipment.





Original HUCK Bird's Nest

Art. No. 4650



NEW COLORS
OF THE ROPE WRAP
AND MAT!



For symbol explanation see
folding card at the back

Suspension height: 2.00 m – 2.50 m



ca. Ø 1.20 m



1.30 m – 1.55 m



Minimum distance to the
Swing frame: 0.80 m



Rope wrapping:



blue, green, red, beige, black
(colours single or in combination)

Link mat:



neon green, dark green, blue,
yellow, red, pink, beige, black
(colours single or combined)

Suspension ropes:

green, rust-orange, blue, yellow, black,
beige, grey, red, orange-fluorescent,
turquoise, fuchsia

or

Chain protection tube:

black, red



Exceeds the safety requirements of DIN EN 1176-2

- ⊕ extra strong padding
- ⊕ puncture-protected link mat
- ⊕ unbeatable service!
- ⊕ 5-year warranty on all materials
- ⊕ Lifetime Europe-wide return service in case of repair
- ⊕ fair repair costs

⊕ The advantages of our link mat with steel cable chain connection, which has been tried and tested 100,000 times worldwide

The link floor of our Original HUCK Bird's Nest from 2002 shows no damage to plastic links, steel cables or chains.

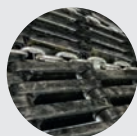

- ⊖ The net bottom of another nest swing from 2013 has already been abraded in its surface to such an extent that the knot connection is only held in place by individual rope strands. Likewise, the steel insert is already completely exposed in places and is infested with rust.



* For durable and long-lasting swinging: All HUCK bird's nest swings with extra-strong abrasion protection at the stressed connections of the suspension chains to the nest basket as well as at the crossing points of the suspension chains!



Trust only the original!

In the HUCK Bird's Nest, the children play on a close-meshed limb mat. As a result, the risk of injury is extremely low. The "chicks" sit on a stepless and gently rounded floor – like their feathered friends in a bird's nest.

Of course, the playground equipment standard also has certain specifications for the upholstery, which the HUCK Bird's Nest clearly surpasses. Another quality criterion: the extra strong abrasion protection for super-stressed connectors and for suspension chains.

A very weather-resistant and cold-flexible hose cover for the HUCK suspension chains provides optimum protection during heavy use. Maintenance is also child's play: the playground equipment can be maintained without any problems

when suspended. You have a 5-year warranty on all materials used and with the right care and maintenance, children can enjoy their playground equipment for a very long time.

Our experience and our standards guarantee quality at the highest level – simply HUCK "Made in Germany"! The name "Bird's Nest" has been a registered trademark of HUCK Seiltechnik GmbH for years.

Conclusion: Only trust the original! Because only the HUCK Bird's Nest combines playfulness, durability and safety.

Take advantage of all Original HUCK Bird's Nest swings!

Safety and high play value

- ⊕ close-meshed link mat
- ⊕ Protection against slipping or sticking through arms and legs
- ⊕ Nest-shaped bottom
- ⊕ extra strong padding

High quality

- ⊕ additional abrasion protection on the connecting parts
- ⊕ Suspension chains with very high-quality, weather-resistant and cold-flexible hose cover
- ⊕ 5-year warranty on all materials

Extremely easy to maintain

- ⊕ Maintenance in the suspended state possible on site
- ⊕ High availability of the Spare parts
- ⊕ HUCK service with collection and redeliv



Original HUCK Honeycomb Nest

Art. No. 4550



Original HUCK Mini Bird's Nest

Art. No. 4650-85



Art. No.	Product description	Diameter	Suspension height	Colour Chain protective sleeve	plank	Suspension height	
						2.00 m	2.50 m
4550*	Original HUCK Honeycomb Nest	1.00 m	2.00 m or 2.50 m	black, red	1.54 m	1.30 m	1.55 m
4650*	Original HUCK Bird's Nest	1.20 m	2.00 m or 2.50 m	black, red	1.90 m	1.30 m	1.55 m
4650-85*	Original HUCK Mini Bird's Nest	0.90 m	2.00 m or 2.50 m	black, red	1.54 m	1.30 m	1.55 m
4650-85M	Original HUCK Mini Bird's Nest for Mini-M-Swing	0.90 m	1.29 m		Mini-M-Swing 1.43 m	Mini-M-Swing 0.50 m	

*Art. No. 4550/4650/4650-85 are manufactured with suspension chains and sleeve as standard; suspension ropes only on request
 Cable color wrapping: green, blue, red (additional charge), black, beige
 Colour of suspension cables: green, orange, fluorescent orange, blue, yellow, black, grey, red, beige, turquoise, fuchsia
 Mat colours: black and neon green



Universal joint including safety bearing
 Art. No. 4608-1

Further information
 on page 205.



Easy-Swing "Honeycomb Nest"









Art. No. 4591-50-3

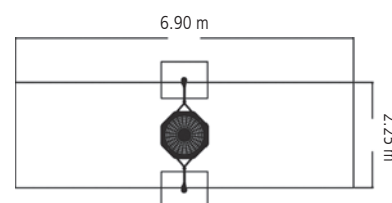

Photo shows Mini Bird's Nest as attachment

For symbol explanation see folding card at the back

Suspension height: Can be easily adjusted, 1.40 - 2.00 m
Sitting area: Ø 1.00 m, Octagonal

-  2.44 m
-  2.50 x 1.00 m
-  15.50 m²
-  6.90 x 2.25 m
-  1.35 m
-  0.80 m³
-  3
- 



Please note!

The space required for foundations (assembly space) is bigger than the minimum space requirement for the equipment.

Equipment
2 Steel posts (Ø 102 mm), hot-dip galvanised, length 3.40 m



Easy-Swing "Swing Bed"







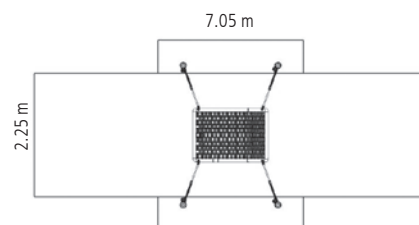

Art. No. 4591-50-9



For symbol explanation see folding card at the back

Suspension height: Can be easily adjusted, max. 2.00 m
Sitting area: 1.20 x 0.90 m



-  2.44 m
-  2.65 x 1.85 m
-  15.60 m²
-  7.05 x 2.25 m
-  1.25 m
-  2.90 m³
-  5
- 
- 



Please note!

The space required for foundations (assembly space) is bigger than the minimum space requirement for the equipment.

Equipment

4 Steel posts (Ø 102 mm), hot-dip galvanised, length 3.40 m



Easy-Swing "Midi"

Art. No. 4591-50-2

Sitting area (W x H x D): 0.55 m x 0.90 m x 0.60 m



Easy-Swing "Maxi"

Art. No. 4591-50-1

Sitting area (W x H x D): 0.80 m x 1.05 m x 0.80 m



For symbol explanation see folding card at the back

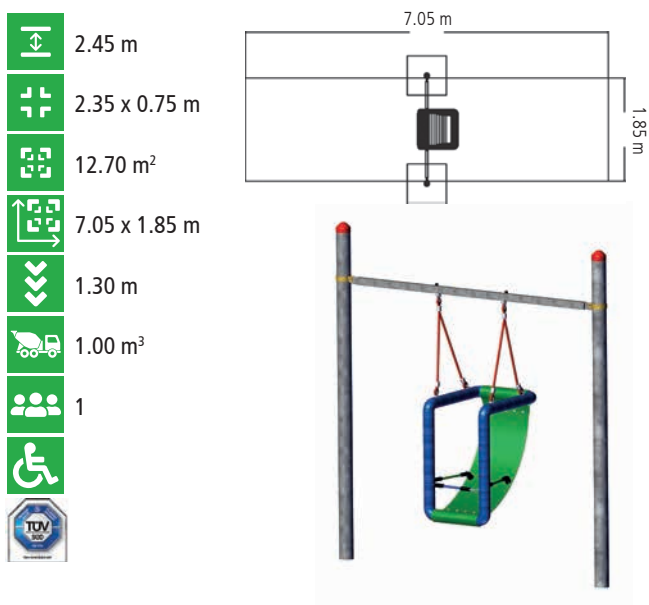

Please note!

The space required for foundations (assembly space) is bigger than the minimum space requirement for the equipment.

Equipment

2 Steel posts (Ø 102 mm), hot-dip galvanised, length 3.40 m, Inc. Posts and suspension bearings

Subject to Technical changes

For symbol explanation see folding card at the back



Please note!

The space required for foundations (assembly space) is bigger than the minimum space requirement for the equipment.



Mini-M-Swing

Art. No. 4540-10 Posts with suspension bearings without attachments*

Art. No. 4540-10-04 Posts with suspension bearings, powder-coated, without attachments*

Art. No. 4540-10A Set Dig-in ground anchor hot-dip galvanized



For symbol explanation see folding card at the back

Suspension height: 1.29 m

 2.30 x 0.90 m

 8.70 m²

 3.95 x 2.20 m

 0.50 m

 1.00 m³

 4

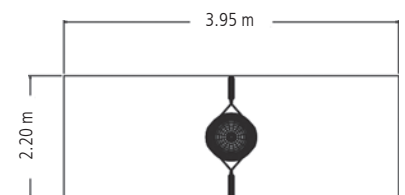

SUPER PRACTICAL!

With dig-in anchors this play equipment is simply set up and can be played on immediately (Art. No. 4540-10A)

Please note!

The space required for foundations (assembly space) is bigger than the minimum space requirement for the equipment.

Now with a lower basket height for an easier start! For the smallest!

*Recommended attachment:

Original HUCK Mini Bird's Nest
Art. No. 4650-85M
(Page 148)

Toddler Swing Seat
Art. No. 4693M



Swings



Art. No. 4693-10



Art. No. 4693



Art. No. 4693-70



Art. No. 4712



Art. No. 5720-1



Art. No. 4700-08



Art. No. 491



Art. No. 4698-1

 Art. No. 5720
(for private use)

Art. No.	Product description	Design Attachment	Suspension height	Required suspension bearings (Page 204)
4693-10	Baby Seat	Hercules rope, coloured	2.00 - 2.50 m	2x Art. No. 4602 Articulated swing hook
4693	Toddler Swing Seat	Hercules rope, coloured	2.00 - 2.50 m	inclusive 2x Art. No. 4602 Articulated swing hook
4693-70	Double Toddler Swing	Hercules rope, coloured	2.00 - 2.50 m	2x Art. No. 4602 Articulated swing hook
4712	Safety Swing Seat with chain	2.00 m Chain, galvanized	2.50 m	2x Art. No. 4602 Articulated swing hook
5720-1	Swing Seat with chain	2.00 m Chain, galvanized	2.50 m	2x Art. No. 4602 Articulated swing hook
4700-08	Rustic Board Swing (for private use)	14 mm Ø PP-Multi strand rope, beige	2.00 - 2.50 m	2x Art. No. 4602 Articulated swing hook
491	Pendulum Seat with chain	2.00 m chain with sleeve		inclusive Art. No. 4603 Swivel
4698-1	Simple Tyre Swing		2.00 m - 2.50 m	2x Art. No. 4602 Articulated swing hook
5720	Swing Seat	PP-Multi strand rope, blue or white	2.00 - 2.50 m	2x Art. No. 4602

All measured lengths for ground clearance of approx. 40 cm



Art. No. 4610 | 4611



Art. No. 4620



Art. No. 4630

Art. No.	Product description	Design Attachment	Dimensions	Suspension height	Drill-hole distance	Minimum distance to frame	Required suspension bearings (Page 204)
4610	Climbing Chimney without ground anchor	Hercules rope coloured	Ø 70 cm	2.00 or 2.50 m	-	1.00 m	Inclusive 1x Art. No. 4608-2 Universal Joint
4611	Climbing Chimney with ground anchor	Hercules rope coloured	Ø 70 cm	2.00 or 2.50 m	-	0.70 m	Inclusive 1x Art. No. 4608-2 Universal Joint
4620	Rope Ring Swing Carousel without ground anchor	Hercules rope coloured	Ø 70 cm	2.00 or 2.50 m	-	1.00 m	Inclusive 1x Art. No. 4608-2 Universal Joint
4630	Oval Rope Swing	2x v-shaped chain, red chain sleeves	1.05 x 0.60 m	2.00 or 2.50 m	0.70 m	0.80 m	Inclusive 2x Art. No. 4608-3 Articulated swing hook



Art. No. 4695



Art. No. 4695-30



Chair also available in orange.



Art. No. 4696

Art. No.	Product description	Design Attachment	Dimensions	Suspension height	Drill-hole distance	Minimum distance to frame	Required suspension bearings (Page 204)
4695	Swing Seat Maxi	2x v-shaped chain, red chain sleeves	0.80 x 1.10 x 0.80 m	2.00 or 2.50 m	0.80 m	0.70 m	Inclusive 2x Art. No. 4608-3 Articulated swing hook
4695-30	Swing Seat Midi	2x v-shaped chain, red chain sleeves	0.60 x 0.90 x 0.60 m	2.00 or 2.50 m	0.55 or 0.60 m	0.65 m	Inclusive 2x Art. No. 4608-3 Articulated swing hook
4696	Swing Seat Mini	2x v-shaped Hercules rope, red and green	0.60 x 0.30 x 1.20 m	2.00 or 2.50 m	0.55 or 0.60 m	0.65 m	Inclusive 2x Art. No. 4608-3 Articulated swing hook

All length dimensions for ground clearance of approx. 40 cm





Art. No. 4771-08



Art. No. 4772-08

Art. No.	Product description	Design Attachment	Dimensions	Suspension height	Minimum distance to frame	Required suspension bearings (Page 204)
4771-08	Partner Swing "Rustikal"	3x suspension chains with red Chain sleeve	140 x 140 mm, Width approx. 1.70 m	2.00 or 2.50 m	0.60 m	3x Art. No. 4602 Articulated swing hook
4772-08	Trio Swing	4x suspension chains with red Chain sleeve	140 x 140 mm, Width approx. 1.90 m	2.00 or 2.50 m	0.60 m	4x Art. No. 4602 Articulated swing hook



Art. No. 4585-40



Art. No. 4770-08-200 | 4770-08-250



Art. No. 4651-20

Art. No.	Product description	Design Attachment	Dimensions	Suspension height	Drill-hole distance	Minimum distance to frame	Required suspension bearings (Page 204)
4585-40	Rope-end Swing	Hercules rope coloured	140 x 140 mm, Length approx. 1.90 m	2.00 or 2.50 m	1.90 m	0.90 m	2x Art. No. 4608 Universal Joint
4770-08-200/250	Jungle Rope Swing	2 x Chain 8 mm galvanized	90 x 90 mm, Total length approx. 3.60 m	2.00 or 2.50 m	2.00 m	0.70 m	2x Art. No. 4608 Universal Joint
4651-20	Swing Bed	4 x Hercules rope coloured	1.20 x 0.90 m	2.00 - 2.50 m	-	0.80 m	Art. No. 4608-1 Universal Joint Incl. safety bearings



Plastic Link Hammock







with links and steel rope

Art. No. 806



For symbol explanation see folding card at the back

Lying area: 0.80 x 1.80 m

-  1.60 m
-  4.65 x 0.90 m
-  16.90 m²
-  4.90 x 3.90 m
-  0.65 m
-  5



Technical data is based on specific example and changes according to installation height

Please note!
The space required for foundations (assembly space) is bigger than the minimum space requirement for the equipment.







Band Hammock

Art. No. 807



For symbol explanation see folding card at the back

Lying area: 0.80 x 1.95 m

-  1.60 m
-  4.65 x 0.90 m
-  16.90 m²
-  4.90 x 3.90m
-  0.65 m
-  5



Technical data is based on specific example and changes according to installation height

Please note!
The space required for foundations (assembly space) is bigger than the minimum space requirement for the equipment.

Posts for hammocks incl. suspension bearings

Art. No. 805S Steel posts / Ø 102 mm, Length 2.40 m

Art. No. 805PS Douglas fir posts / Ø 180 mm, Length 2.70 m with post shoes

Art. No. 805R Robinia wood posts / Ø 160-200 mm, Length 2.80 m with steel shoes



Hercules Rope Hammock

with clip fixings
Art. No. 808VA









Hercules Rope Hammock

with cross-stitch
Art. No. 808KS



For symbol explanation see folding card at the back

Lying area: 0.80 x 1.80 m







-  1.60 m
-  4.65 x 0.90 m
-  16.90 m²
-  4.90 x 3.90 m
-  0.65 m
-  5
- 

Technical data is based on specific example and changes according to installation height

Please note!
The space required for foundations (assembly space) is bigger than the minimum space requirement for the equipment.

For symbol explanation see folding card at the back

Lying area: 0.80 x 1.80 m

-  1.60 m
-  4.65 x 0.90 m
-  16.90 m²
-  4.90 x 3.90 m
-  0.65 m
-  5
- 

Technical data is based on specific example and changes according to installation height

Please note!
The space required for foundations (assembly space) is bigger than the minimum space requirement for the equipment.



Polyester Hammock

Art. No. 807-200



For symbol explanation see folding card at the back

Lying area: 0.65 x 1.50 m



1.44 m



3.15 x 0.65 m



14.20 m²



4.40 x 3.65 m



0.65 m



0,80 m³



5



Technical data is based on specific example and changes according to installation height

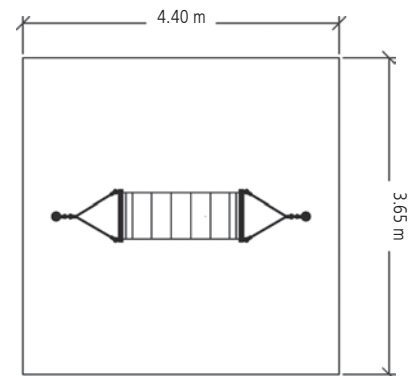

Steel posts for polyester Hammocks incl. Suspension bearings

Art. No. 805-200

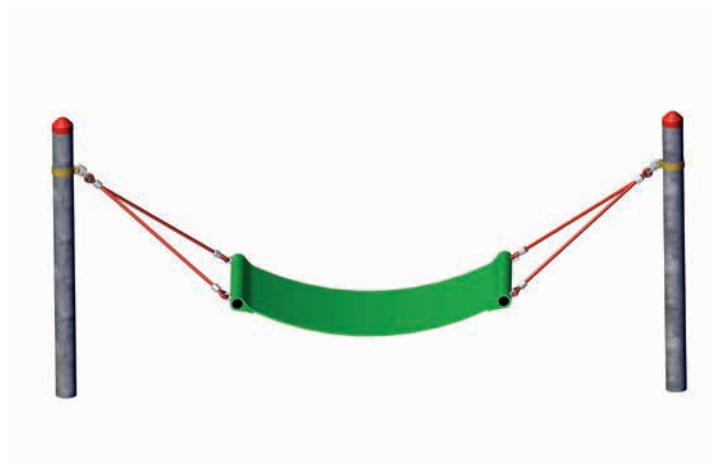





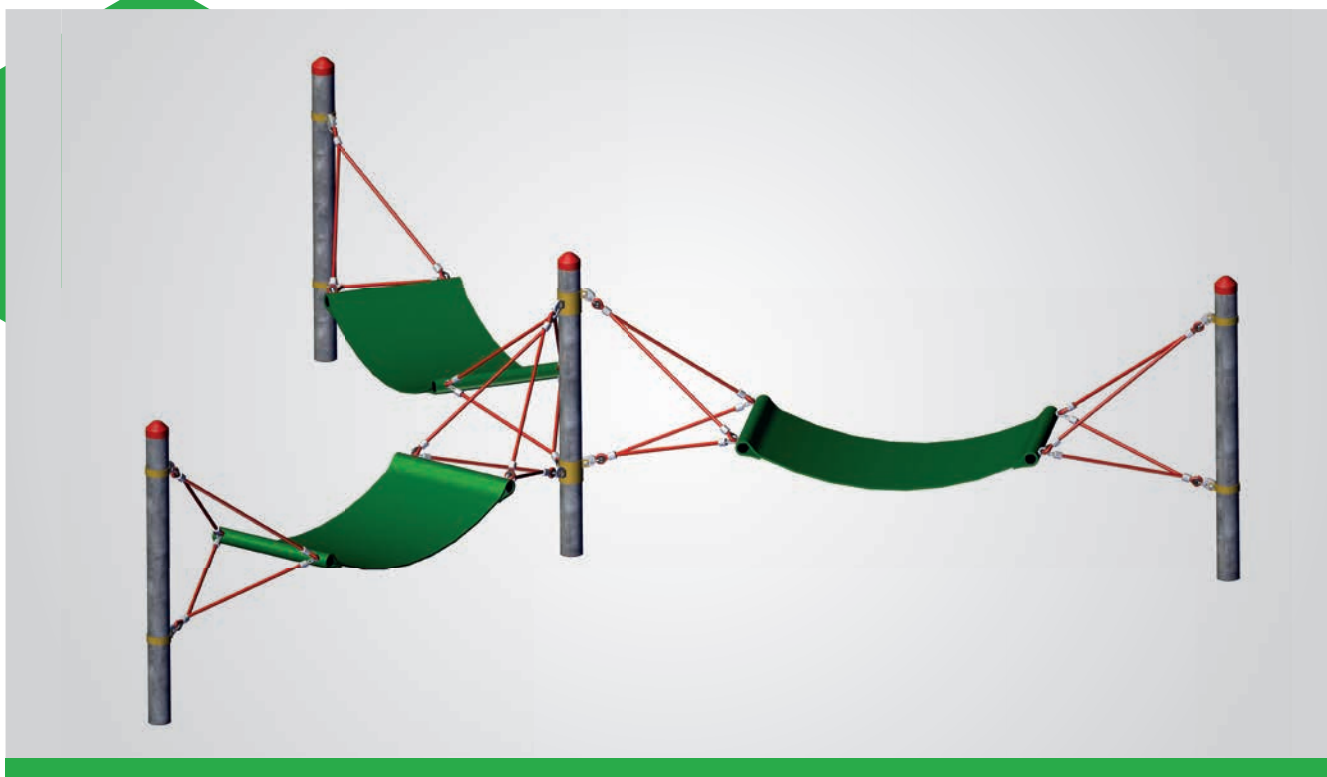



Hammock Trio

Art. No. 807-100



For symbol explanation see folding card at the back

Lying area: 0.65 x 1.50 m (3x)

-  1.44 m
-  Ø 6.15 m
-  31.90 m²
-  6.60 x 6.60 m
-  0.70 m
-  1.55 m³
-  15
- 

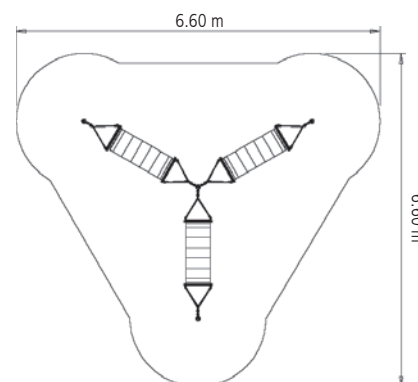

Other options on request.

Equipment
4 Steel posts (Ø 102 mm),
length 2.40 m

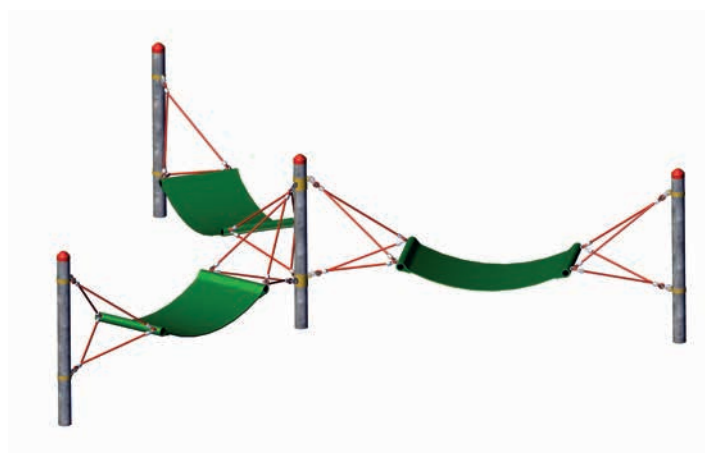











XXL-Hammock for Arch Steel Frame

Art. No. 808-2



For symbol explanation see folding card at the back

Lying area: 2.00 x 1.40 m

-  1.35 m
-  4.45 x 4.15 m
-  20.60 m²
-  4.55 x 5.00 m
-  0.60 m
-  2.20 m³
-  7
- 

Please note!
The space required for foundations (assembly space) is bigger than the minimum space requirement for the equipment.

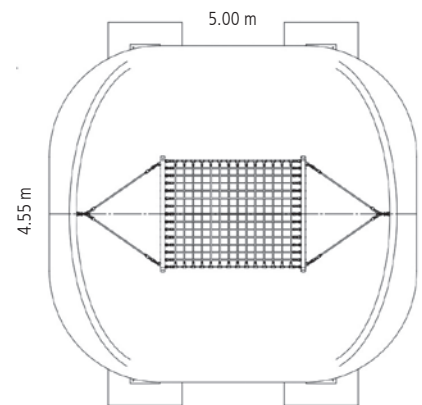

Arch Steel Frame for XXL Hammock
incl. suspension bearings
Art. No. 805SB Steel, Ø 159 mm

Hercules Rope Hammock with plastic knotballs

Art. No. 808



For symbol explanation see
folding card at the back

Lying area: 0.81 x 1.80 m

 1.60 m

 4.65 x 0.90 m

 16.90 m²

 4.90 x 3.90 m

 0.65 m

 5



Technical data is
based on specific
example and
changes according
to installation
height

Equipment
Hammock without posts







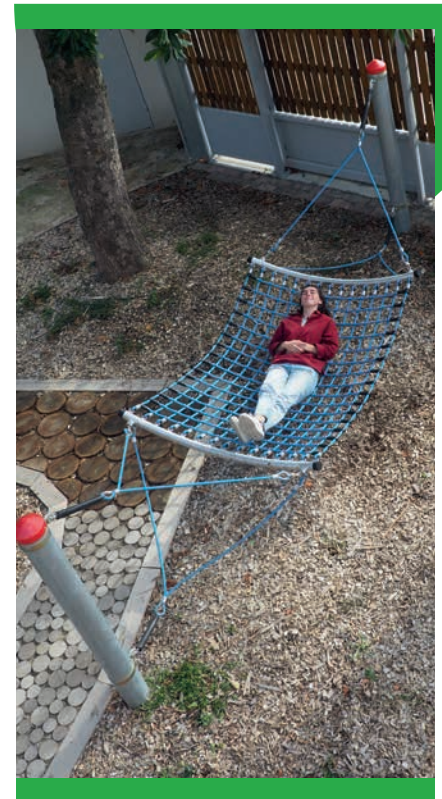



XXL Rest Hammocks

Art. No. 808-1



For symbol explanation see folding card at the back

Lying area: 2.00 x 1.40 m

-  1.75 m
-  5.20 x 1.60 m
-  21.00 m²
-  5.00 x 4.60 m
-  0.60 m
-  1.15 m³
-  7
- 
- 

Please note!
The space required for foundations (assembly space) is bigger than the minimum space requirement for the equipment.

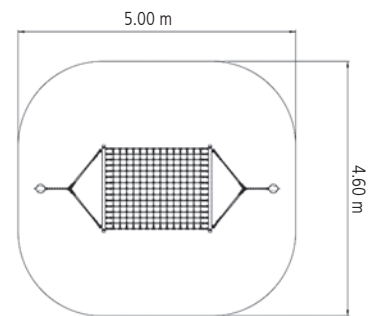

Posts for XXL Rest Hammocks,
incl. suspension bearings
Art. No. 808-1S Steel (Ø 159 mm), Length 2.70 m

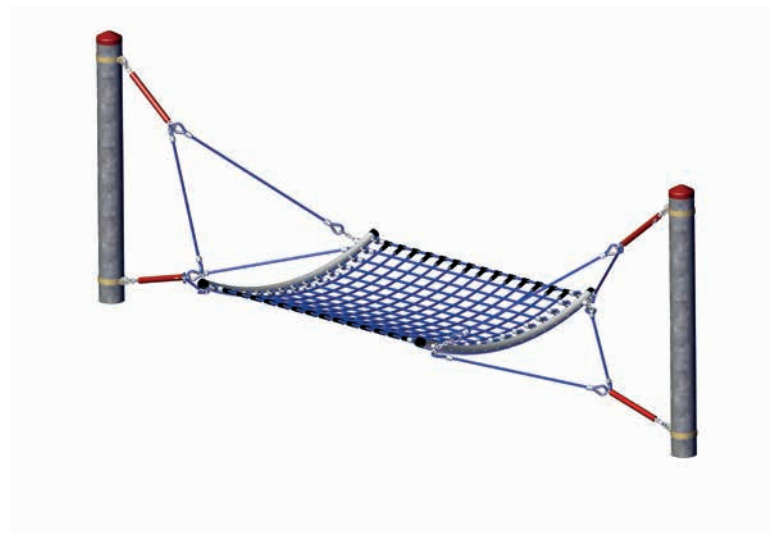

Bird's Nest "Chill Out" XXL









Art. No. 803

Art. No. 803-US IPEMA-certified



For symbol explanation see folding card at the back

Lying area: Ø 1.80 m

-  1.75 m
-  4.85 x 1.95 m
-  19.30 m²
-  Ø 4.95 m
-  0.75 m
-  1.45 m³
-  8
- 
- 

Equipment
2 Steel posts (Ø 159 mm),
length 2.70 m

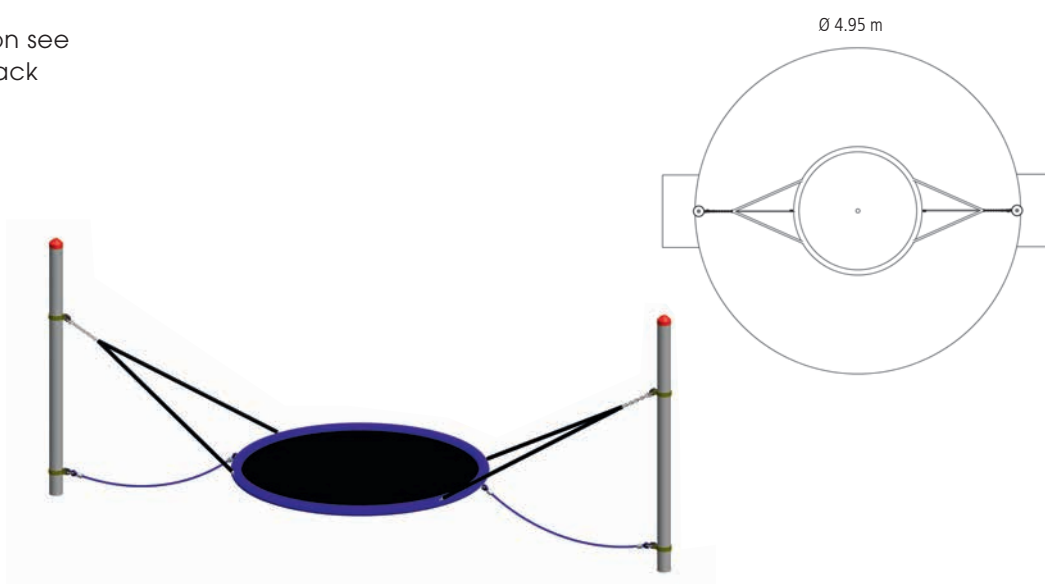

Please note!
The space required for foundations (assembly space) is bigger than the minimum space requirement for the equipment.

- ⊕ Perfect as a group swing for little ones
- ⊕ Perfect as a therapy swing for adults
- ⊕ Swinging motion can be individually controlled
- ⊕ 5-year full guarantee



LET'S PLAY!

ROPE NET PYRAMIDS

Our rope pyramids combine it all in one big adventure. Whether in kindergartens, public playgrounds, schools or adventure parks. Extraordinary heights can be safely reached by our varying net levels or nest baskets. Where you can relax and enjoy the view.

PRODUCT HIGHLIGHT

Our rope net pyramid not only offers colorful choices for nets and bird nests, but also space for up to 85 children to climb and play together.

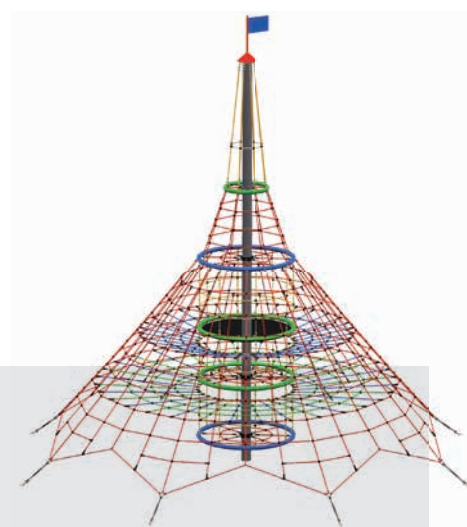

Rope Net Pyramid
DINO XXL
Page 177











Triops-Pyramid Mini

Art. No. 4644-1



For symbol explanation see folding card at the back

-  3.25 m
-  4.60 x 4.00 m
-  17.10 m²
-  4.80 x 4.60 m
-  0.65 m
-  1.30 m³
-  10
- 

Please note!

The space required for foundations (assembly space) is bigger than the minimum space requirement for the equipment.

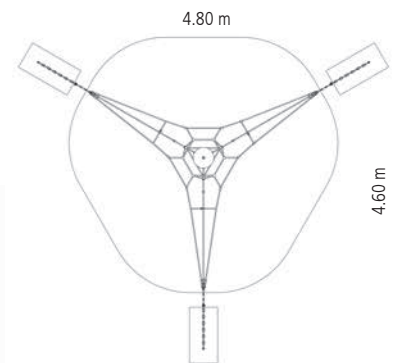









SPIDER 4 Pyramid with 4 guy lines

Art. No. 5000-4-4



For symbol explanation see folding card at the back

-  4.35 m
-  5.90 x 5.90 m
-  52.20 m²
-  7.80 x 7.80 m
-  0.95 m
-  8.70 m³
-  18
- 

Please note!
The space required for foundations (assembly space) is bigger than the minimum space requirement for the equipment.

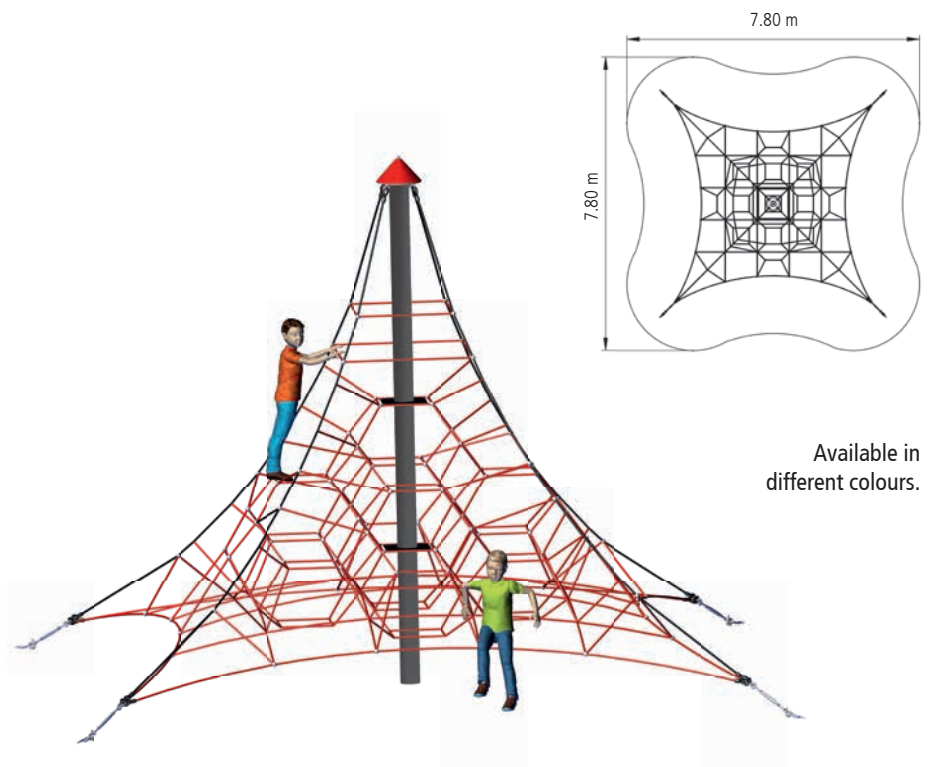

Available in different colours.











SPIDER 6 Pyramid with 4 guy lines

Art. No. 5000-6-4



For symbol explanation see folding card at the back

-  6.40 m
-  8.75 x 8.75 m
-  97.30 m²
-  10.40 x 10.40 m
-  1.85 m
-  8.70 m³
-  51
- 

Please note!
The space required for foundations (assembly space) is bigger than the minimum space requirement for the equipment.

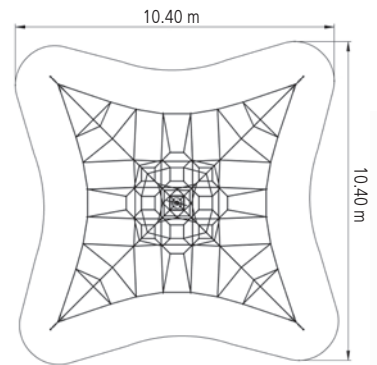

Available in different colours.

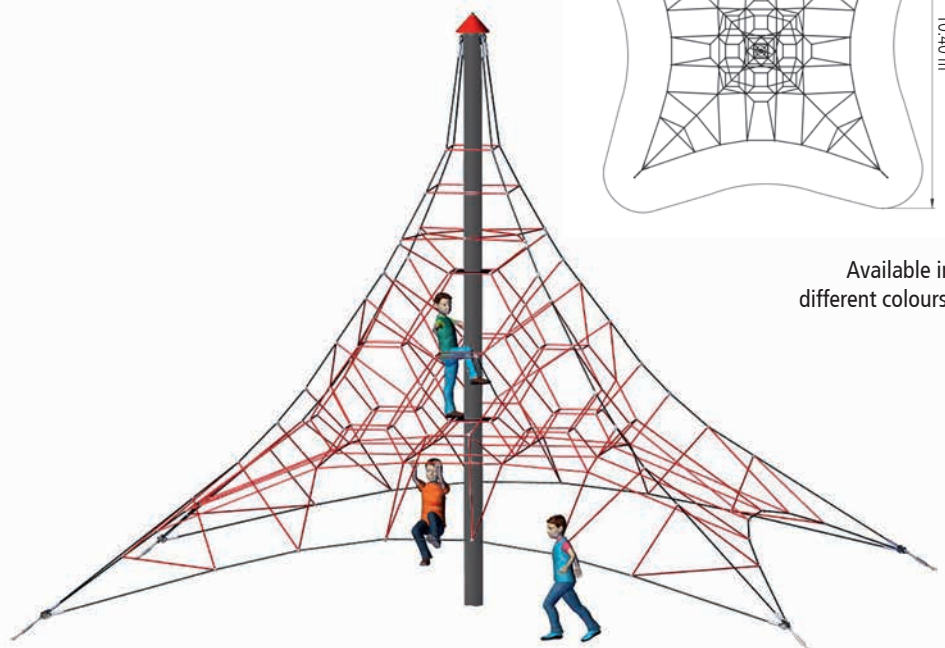

SPIDER 6 Pyramid with 6 guy lines

Art. No. 5000-6-6



For symbol explanation see folding card at the back

-  6.40 m
-  11.30 x 9.80 m
-  109.00 m²
-  11.80 x 11.60 m
-  1.60 m
-  13.00 m³
-  54
- 

Please note!

The space required for foundations (assembly space) is bigger than the minimum space requirement for the equipment.

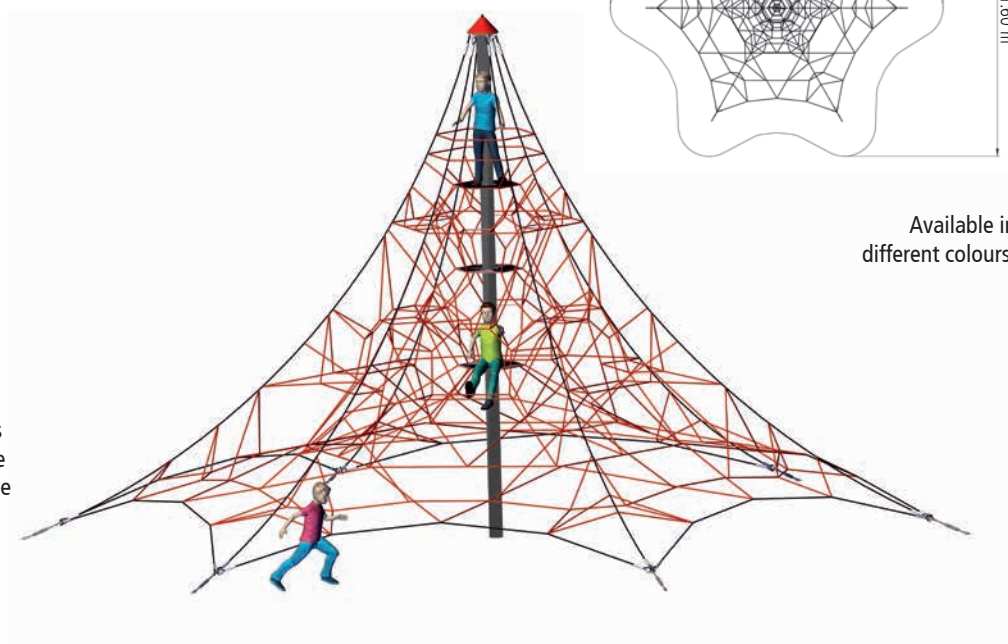
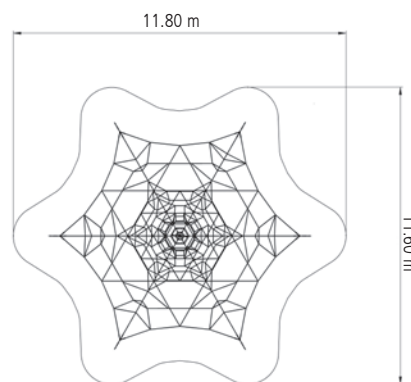

Available in different colours.





SPIDER 8 Pyramid with 6 guy lines

Art. No. 5000-8-6



For symbol explanation see folding card at the back

-  8.15 m
-  12.10 x 13.95 m
-  118.60 m²
-  12.50 x 11.90 m
-  1.80 m
-  13.20 m³
-  73
- 

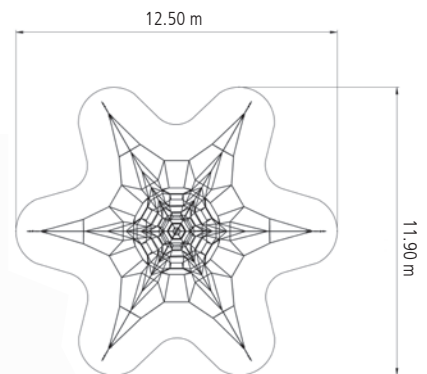

Available in different colours.

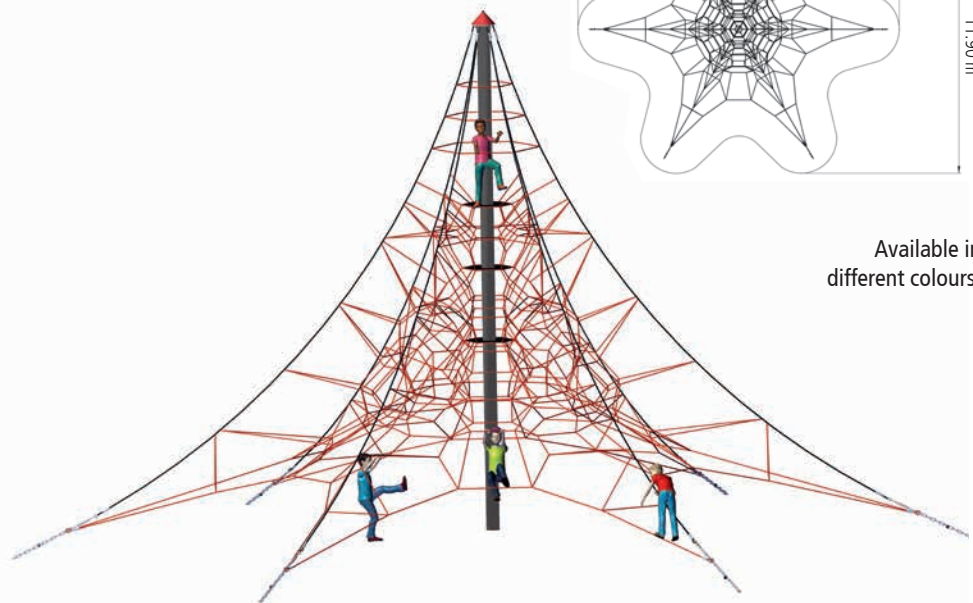

Please note!
The space required for foundations (assembly space) is bigger than the minimum space requirement for the equipment.



Cheops-Pyramid Maxi









Art. No. 4643-3B

Art. No. 4643-3B-US, with alu turnbuckles

Art. No. 4643-3E, to dig-in version



For symbol explanation see folding card at the back

-  5.70 m
-  Ø 11.00 m
-  98.50 m²
-  Ø 11.20 m
-  1.75 m
-  4.50 m³
-  167
- 
- 

Please note!

The space required for foundations (assembly space) is bigger than the minimum space requirement for the equipment.

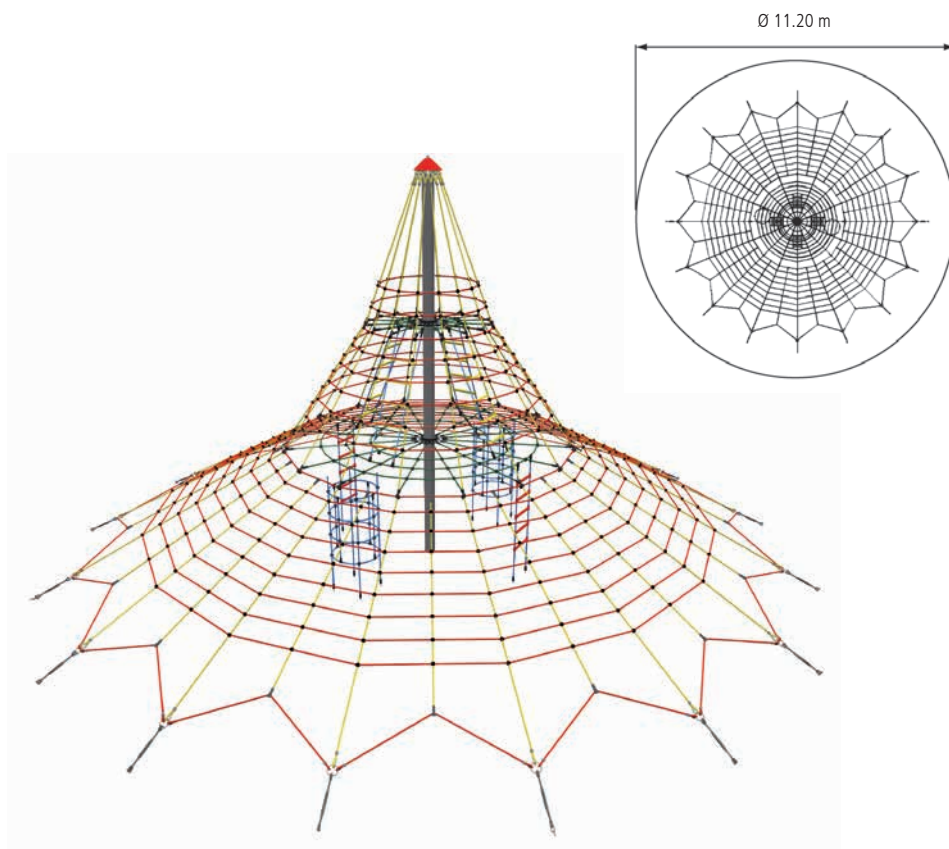



Cheops-Pyramid Midi









Art. No. 4643-2B

Art. No. 4643-2B-US, with alu turnbuckles

Art. No. 4643-2E, to dig-in version



For symbol explanation see folding card at the back

-  4.20 m
-  Ø 8.35 m
-  72.40 m²
-  Ø 9.60 m
-  1.50 m
-  4.30 m³
-  40
- 
- 

Please note!

The space required for foundations (assembly space) is bigger than the minimum space requirement for the equipment.

Ø 9.60 m

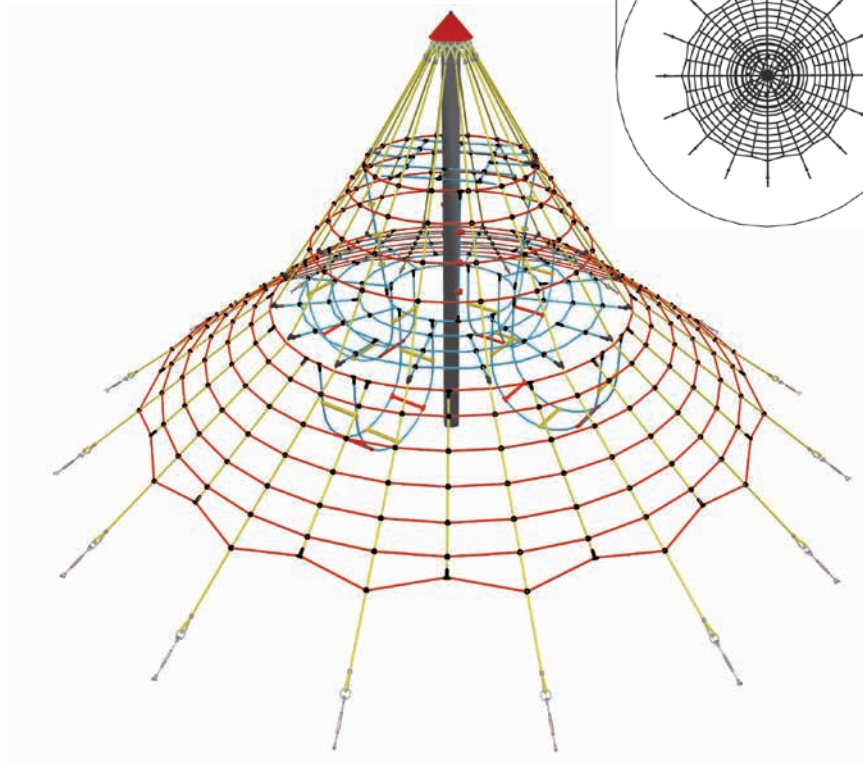
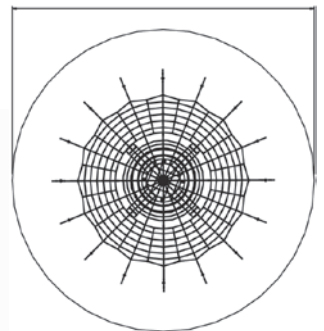









Cheops-Combination Midi

Art. No. 4643-2B-10



For symbol explanation see folding card at the back

-  4.20 m
-  18.85 x 8.35 m
-  139.60 m²
-  17.60 x 9.60 m
-  1.50 m
-  10.20 m³
-  92
- 

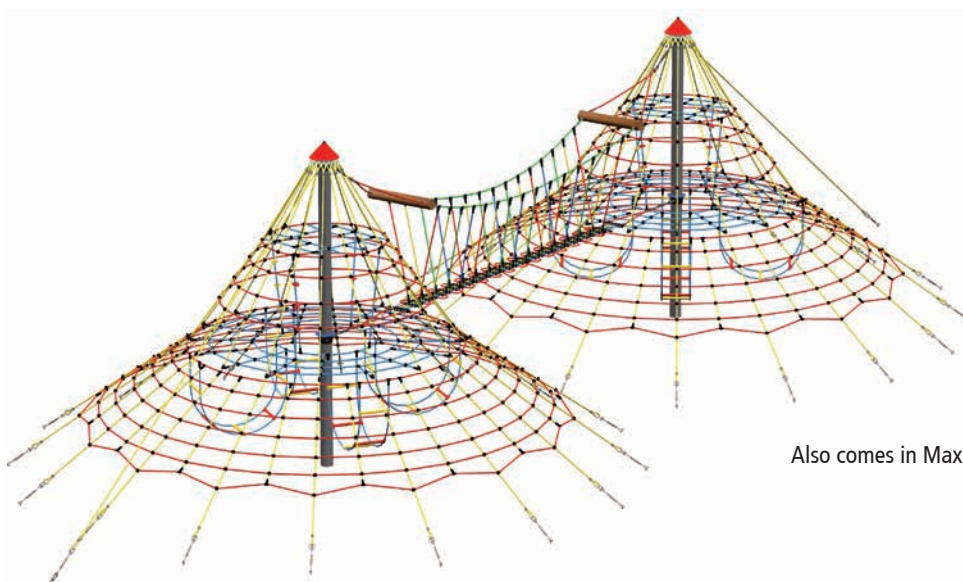
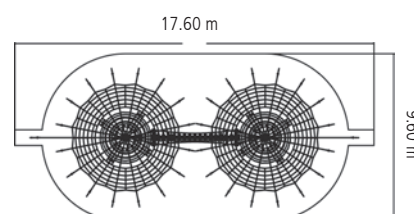

Also comes in Maxi.

Please note!
The space required for foundations (assembly space) is bigger than the minimum space requirement for the equipment.



Cheops-Pyramid Mini









Art. No. 4643-1B

Art. No. 4643-1B-US, with alu turnbuckles

Art. No. 4643-1E, to dig-in version



For symbol explanation see folding card at the back

-  3.50 m
-  Ø 4.05 m
-  33.20 m²
-  Ø 6.50 m
-  1.20 m
-  3.80 m³
-  31
- 
- 

Please note!

The space required for foundations (assembly space) is bigger than the minimum space requirement for the equipment.

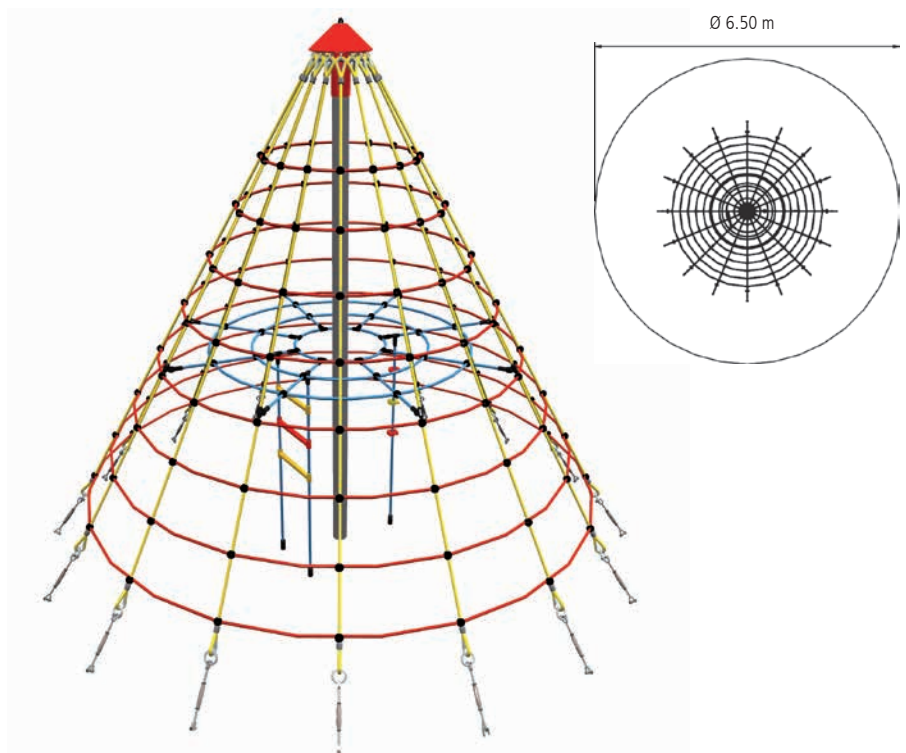









Rope Net Tower 1

Art. No. 4595

Art. No. 4595E, to dig-in version



For symbol explanation see folding card at the back

-  6.05 m
-  Ø 9.50 m
-  105.00 m²
-  Ø 11.60 m
-  2.00 m
-  4.60 m³
-  58
- 
- 

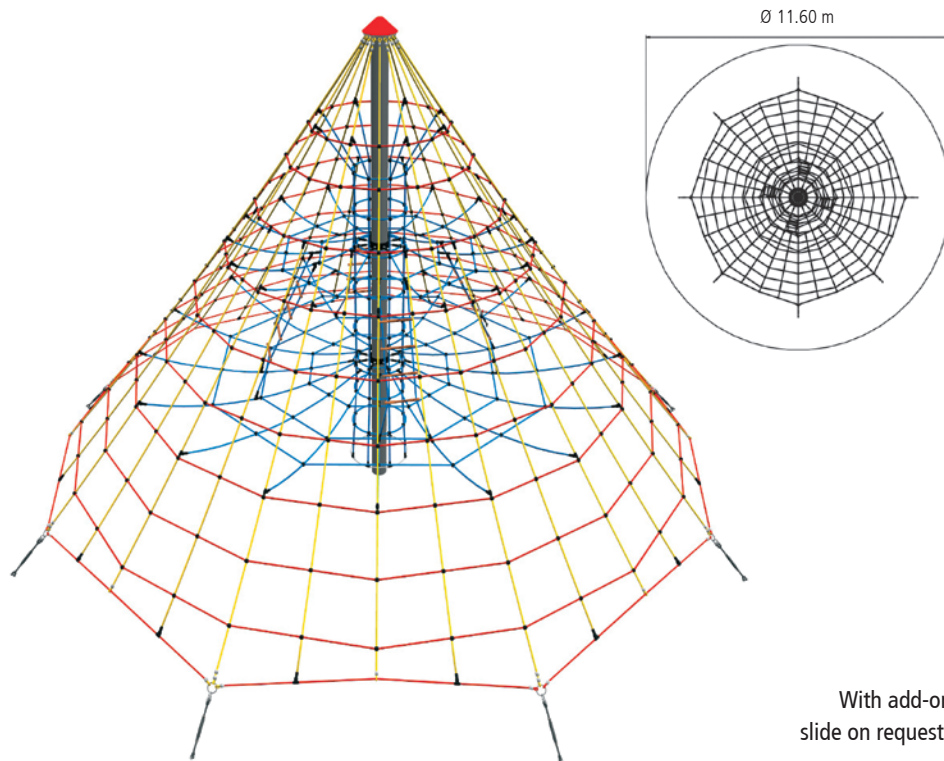

Please note!
The space required for foundations (assembly space) is bigger than the minimum space requirement for the equipment.

With add-on slide on request!



Rope Net Tower 2

Art. No. 4596S

Art. No. 4596E, to dig-in version



For symbol explanation see folding card at the back



4.35 m



Ø 8.00 m



78.55 m²



Ø 10.00 m



1.50 m



4.20 m³



45



Please note!

The space required for foundations (assembly space) is bigger than the minimum space requirement for the equipment.

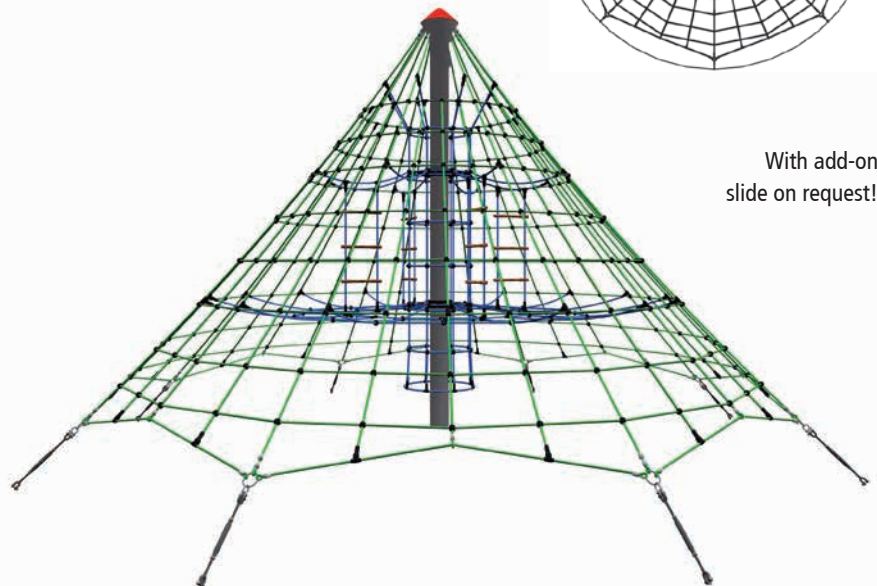
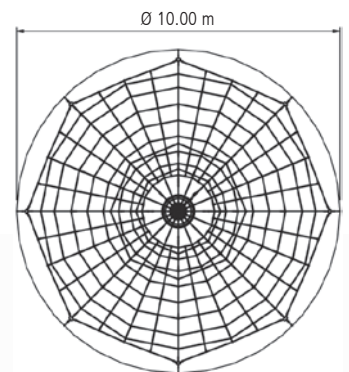









Rope Net Pyramid DINO XXL

Art. No. 10.04.100



For symbol explanation see folding card at the back

-  8.20 m
-  Ø 9.55 m
-  95.00 m²
-  Ø 11.00 m
-  1.75 m
-  4.30 m³
-  85
- 

Please note!

The space required for foundations (assembly space) is bigger than the minimum space requirement for the equipment.

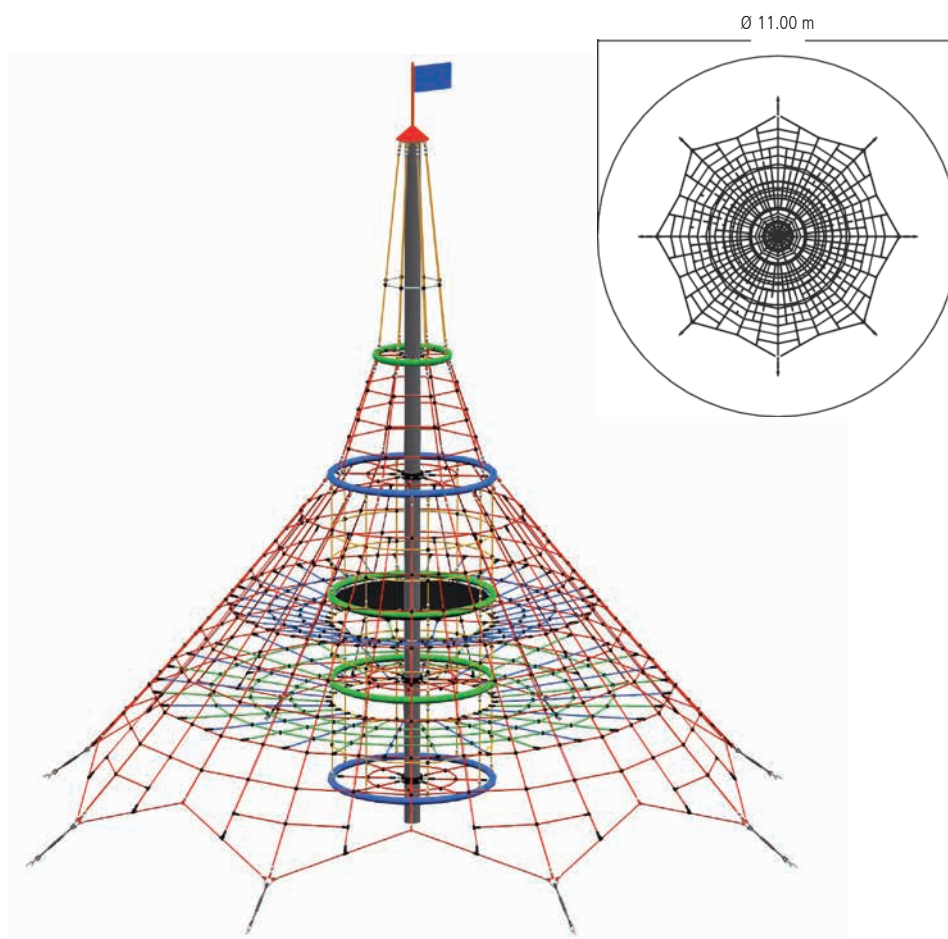











Rope Net Pyramid DINO 1

Art. No. 10.01.100

Art. No. 10.01.100E, to dig-in version



For symbol explanation see folding card at the back

-  6.15 m
-  Ø 9.55 m
-  95.00 m²
-  Ø 11.00 m
-  1.75 m
-  4.10 m³
-  83
- 
- 

Please note!

The space required for foundations (assembly space) is bigger than the minimum space requirement for the equipment.

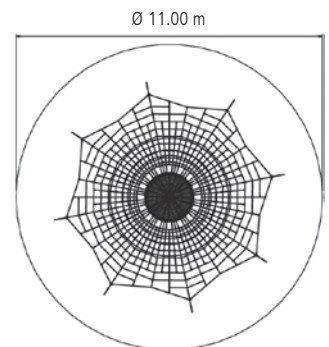

With add-on slide on request!

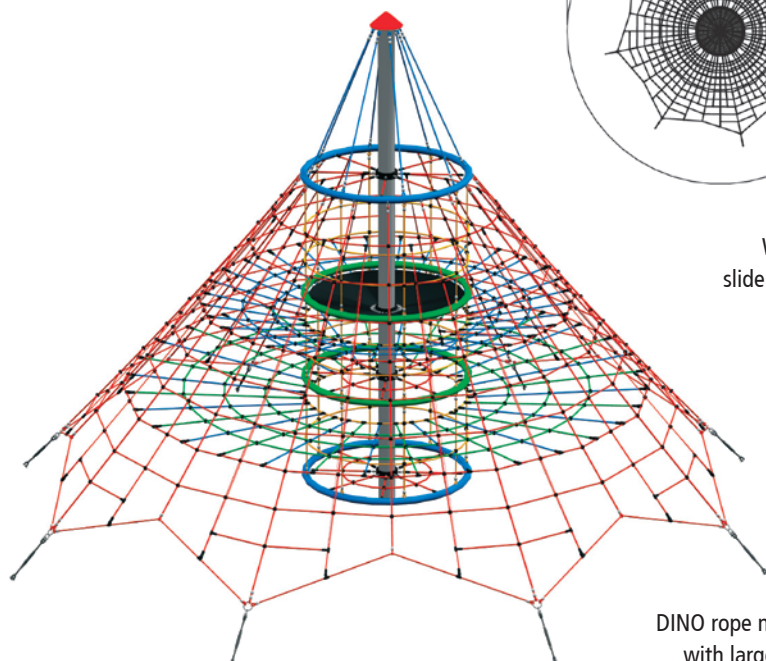

DINO rope net pyramids with large bird's nest for chilling out.



Rope Net Pyramid DINO 2

Art. No. 10.02.100S

Art. No. 10.02.100E, to dig-in version



For symbol explanation see folding card at the back

4.45 m

Ø 7.75 m

66.50 m²

Ø 9.20 m

1.50 m

4.30 m³

59



Please note!

The space required for foundations (assembly space) is bigger than the minimum space requirement for the equipment.

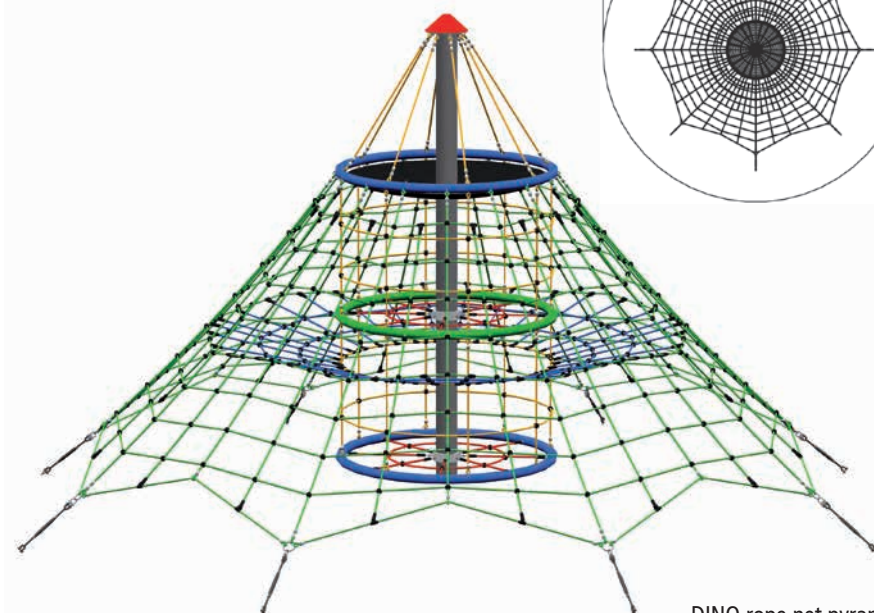
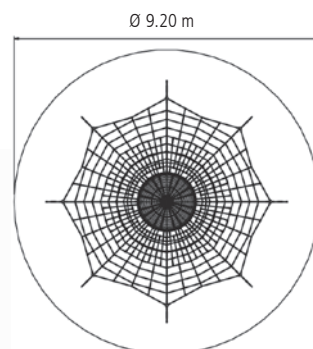

DINO rope net pyramids with large bird's nest for chilling out.











Rope Net Pyramid DINO 3

Art. No. 10.03.100S

Art. No. 10.03.100E, to dig-in version



For symbol explanation see folding card at the back

-  3.20 m
-  Ø 5.60 m
-  35.00 m²
-  Ø 6.70 m
-  1.75 m
-  3.40 m³
-  27
- 
- 

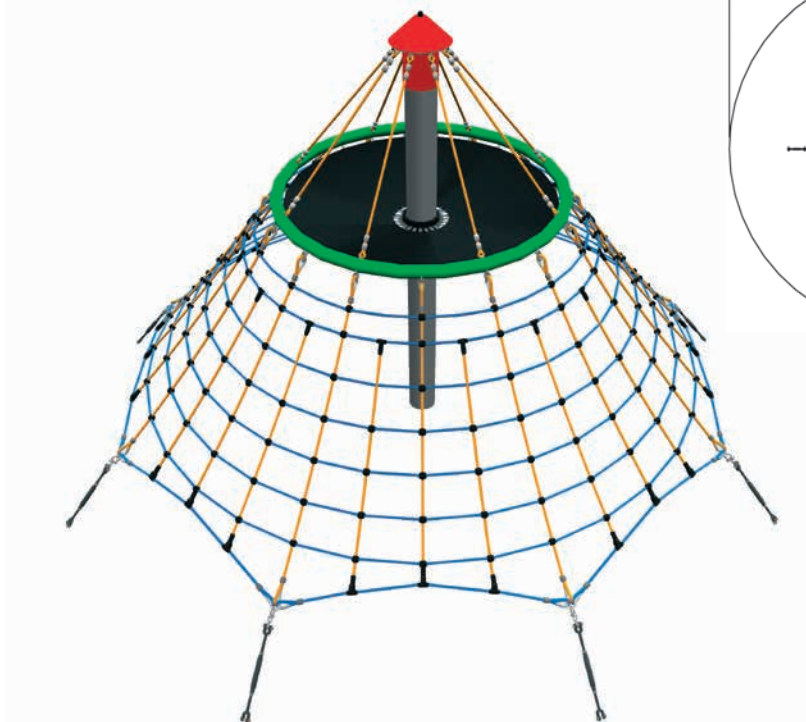

Ø 6.70 m

DINO rope net pyramids
with large bird's nest
for chilling out.











Rope Net Pyramid DINO Mini

Art. No. 10.05.100



For symbol explanation see folding card at the back

-  2.25 m
-  3.70 x 3.50 m
-  25.00 m²
-  5.80 x 5.65 m
-  0.80 m
-  0.70 m³
-  13
- 

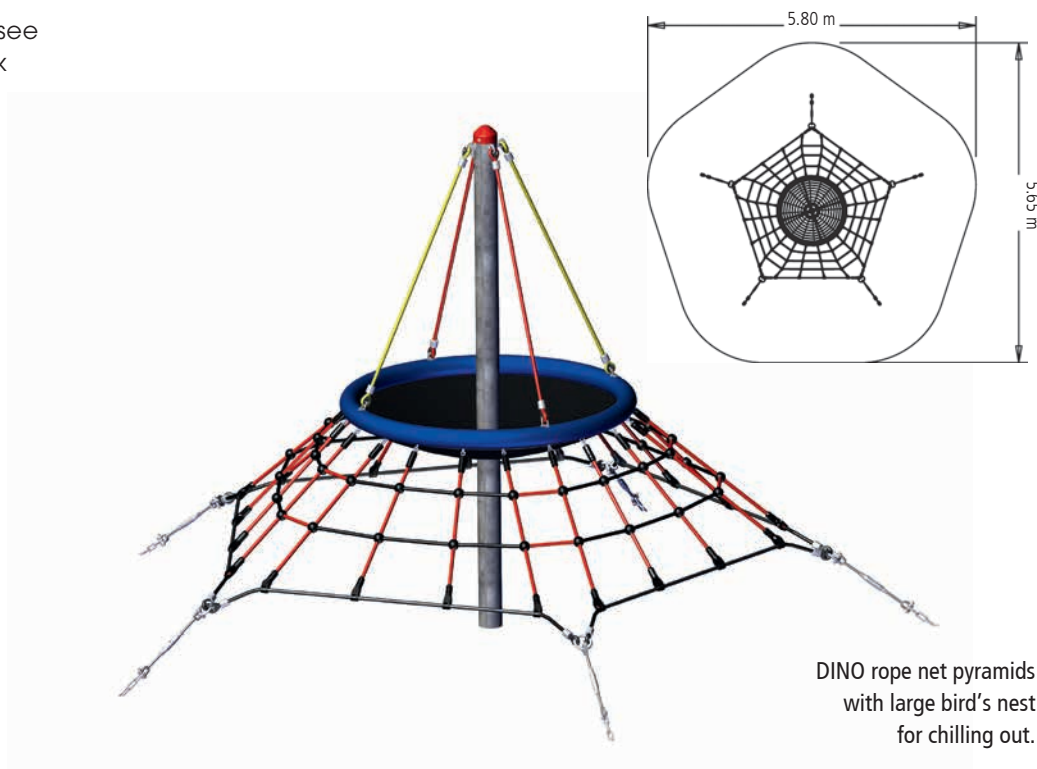

DINO rope net pyramids with large bird's nest for chilling out.









Super-Climb Maxi

Art. No. 4641-1

Art. No. 4641-1E, to dig-in version



For symbol explanation see folding card at the back

-  5.55 m
-  6.20 x 6.20 m
-  72.20 m²
-  8.60 x 8.60 m
-  2.00 m
-  4.30 m³
-  53
- 
- 

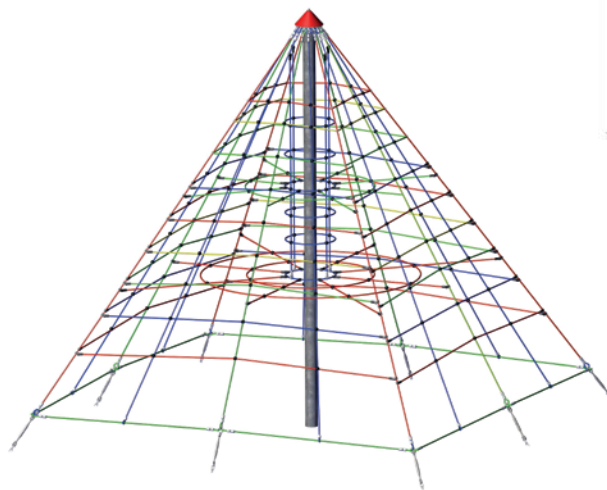
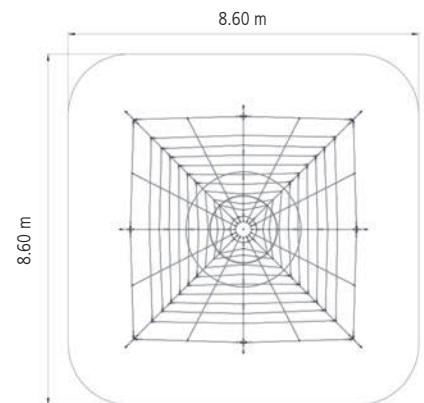

Super-Climb Midi

Art. No. 4641-2

Art. No. 4641-2E, to dig-in version











Super-Climb Mini

Art. No. 4641-3

Art. No. 4641-3E, to dig-in version







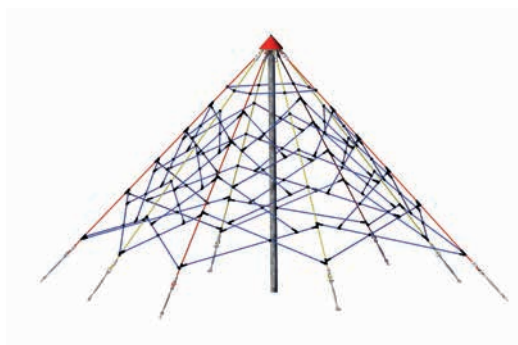
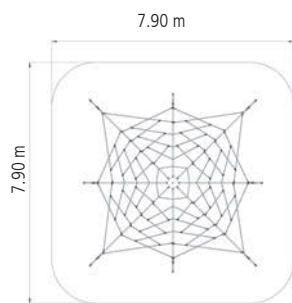



For symbol explanation see folding card at the back

-  3.95 m
-  6.10 x 6.10 m
-  60.00 m²
-  7.90 x 7.90 m
-  3.00 m
-  2.10 m³
-  39
- 
- 



For symbol explanation see folding card at the back

-  2.40 m
-  4.00 x 4.00 m
-  37.75 m²
-  6.30 x 6.30 m
-  1.80 m
-  0.75 m³
-  25
- 
- 

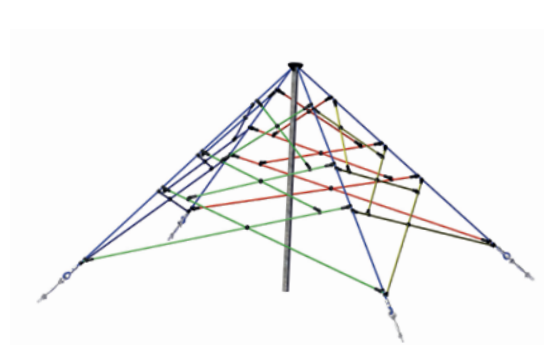
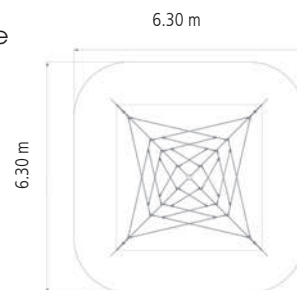











X-Pyramid Maxi

Art. No. 4640-1

Art. No. 4640-1-US, with aluminium connectors



For symbol explanation see folding card at the back

-  4.20 m
-  5.45 x 5.45 m
-  59.30 m²
-  7.85 x 7.85 m
-  3.00 m
-  1.15 m³
-  32
- 

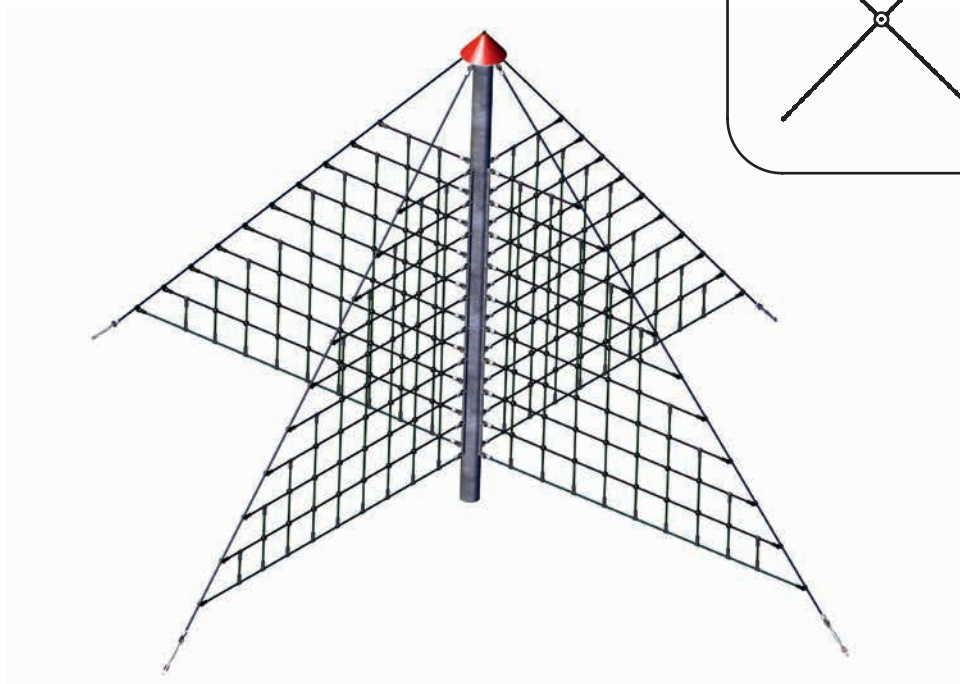
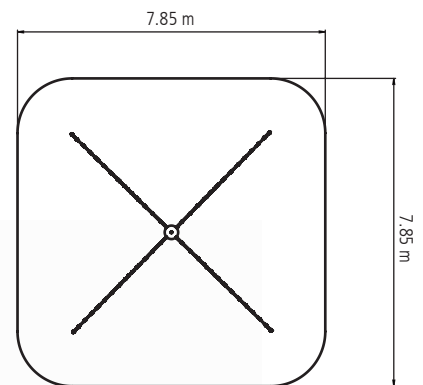





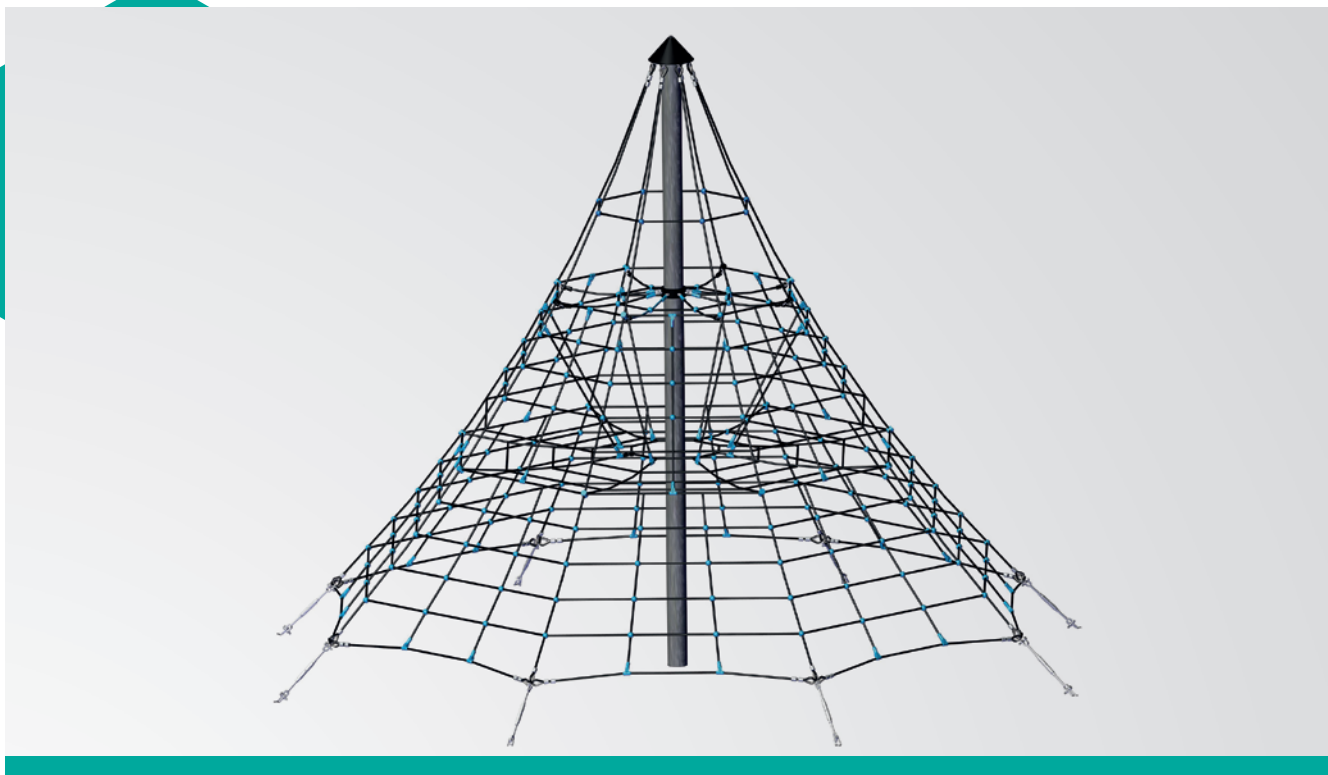



Deep Space Net Pyramid

Art. No. 4641-10S



For symbol explanation see folding card at the back

-  5.20 m
-  Ø 7.00 m
-  64.50 m²
-  Ø 9.00 m
-  1.80 m
-  4.10 m³
-  93
- 

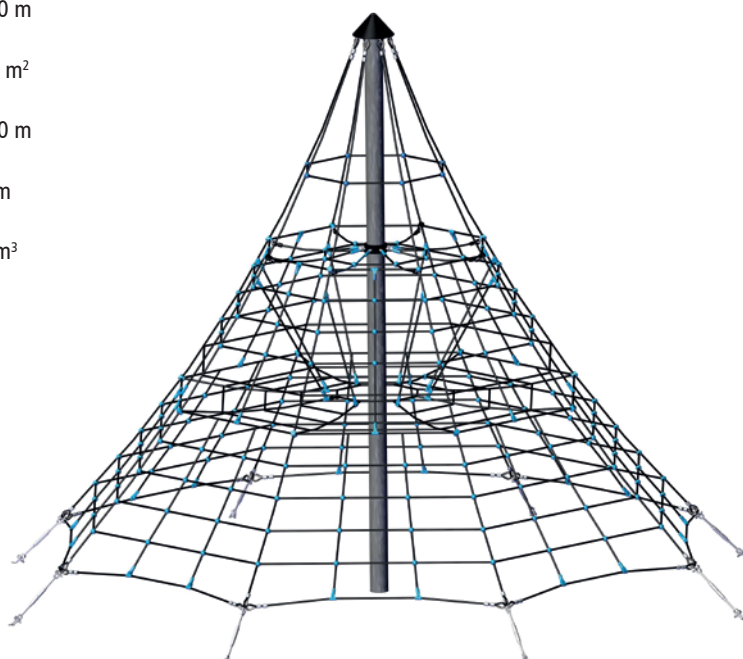

Ø 9.00 m

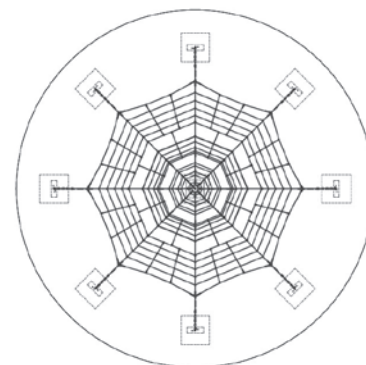

New look with black Hercules rope and blue plastic connectors.



JUMP UP!

Hally-Gally



TRAMPOLINES AND BOUNCER

Jumping makes you happy! Trampolines and bouncer are growing in popularity in playgrounds – no wonder then that children (and parents too) can properly let off steam here. In addition to pure enjoyment bouncing on a trampoline strengthens the muscular system, promotes balance and poise as well as dexterity and motor skills. With the trampolines and bouncer in the Hally Gally range you can enjoy the highest quality and safety in many different designs and for all requirements.

PRODUCT HIGHLIGHT

Movement is a fundamental need for everyone, regardless of impairments. With this thought in mind, we proudly present our trampoline "Rolli". This unique device not only promotes physical activity, but also creates an inclusive environment where everyone can experience the positive effects of exercise.

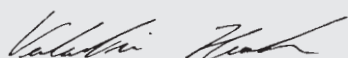

"Rolli" Trampoline -
Wheelchair Friendly
Page 190



Hally Gally Trampolines – according to DIN EN 1176

the original tried and tested a thousand times for twenty-five years now

Our robust trampolines that withstand any load are:

- ⊕ easy to install and maintain
- ⊕ available in various sizes and designs
- ⊕ completely pre-assembled and ready to play
- ⊕ alternatively, are available as a reasonably priced kit



The jumping mats used by us:

- ⊕ have specially created hot-dip galvanised steel springs
- ⊕ have an abrasion-proof jumping area
- ⊕ Made from either special environmentally friendly, soft, recycled rubber slats with woven inserts, plastic links or membranes (woven for strength, PAH free)
- ⊕ have tear-proof wire rope and offer a robust connection
- ⊕ provide the children with a soft and comfortable jumping experience

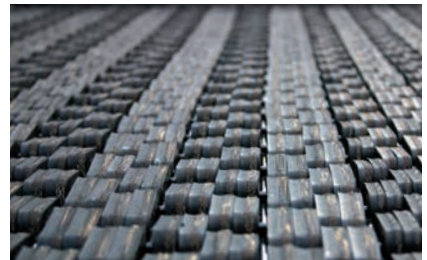

The spring suspensions used by us:

- ⊕ have specially created hot-dip galvanised steel springs
- ⊕ provide unchanged tensile strengths even after years
- ⊕ are distributed based on form and working load
- ⊕ are sound absorbing
- ⊕ facilitate soft jumping movements



The fall protection plates used by us:

- ⊕ are hard-wearing and highly abrasion proof, especially at the edges
- ⊕ provide high quality shock absorption
- ⊕ Standard color red-brown, PAH-free, can also be supplied in black on request
- ⊕ are also available in other colours and in EPDM rubber upon request



The frame structures used by us:

- ⊕ have a complete steel sheet panel frame with reinforcement angles and extra-strong galvanising
- ⊕ are long-lasting and are suitable for permanent burial in moist ground
- ⊕ have a safe and secure hanging solution for steel spring device
- ⊕ have an ultra-strong abrasion protection on supporting areas under the frame
- ⊕ for years now have sound absorption elements between mats and frames

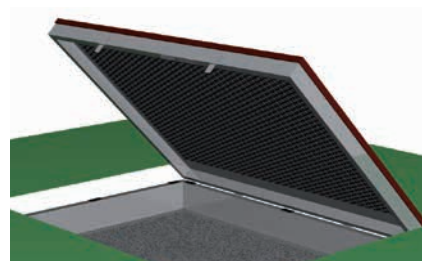

The dig-in frames used by us:

- ⊕ do not need to be set in concrete and multiple start-ups and setting times
- ⊕ form a sturdy and permanent connection with the trampoline

And the maintenance work?

- ⊕ Trampolines are low maintenance
- ⊕ Hanging hooks for trampoline mat included



Over-view of Hally-Gally trampolines

Hally Gally Trampolines – according to DIN EN 1176	Jumping area	External dimensions	Dig-in frames	Jumping mat material	Cleaning
Art. No. 20.02.115 "Rolli"	1.55 x 1.10 m	3.00 x 1.75 m	included	Plastic links	Mat can be hung up
Art. No. 20.02.122 Mini-Trampoline mounted	1.10 x 1.10 m	1.75 x 1.75 m	-	Plastic links	Mat can be hung up
Art. No. 20.02.126 Mini-Trampoline in ground	1.10 x 1.10 m	1.75 x 1.75 m	included	Plastic links	Mat can be hung up
Art. No. 20.02.112G "Circus" with closed mat	Ø 1.30 m	Ø 1.90 m	included	Rubber mat	Mat can be hung up
Art. No. 20.02.104 "Circus Maximus"	Ø 1.90 m	Ø 2.50 m	included	Rubber mat	Mat can be hung up
Art. No. 20.02.106 "Maximus" 6.00 m long	0.98 x 5.34 m	1.65 x 6.00 m	included	Plastic links	Mat can be hung up
Art. No. 20.02.105 "Maximus" 9.00 m long	0.98 x 8.34 m	1.65 x 9.00 m	included	Plastic links	Mat can be hung up
Art. No. 20.02.118 "Piccolo" in ground	0.85 x 0.85 m	1.50 x 1.50 m	included	Rubber mat	Mat can be hung up
Art. No. 20.02.111 "Saturn"	1.00 x 2.00 m	1.50 x 2.50 m	included	Rubber mat	Can be lifted out
Art. No. 20.02.500 "Kangaroo"	0.85 x 3.85 m	4.50 x 1.50 m	included	Rubber mat	Mat can be hung up
Art. No. 20.02.120 "2000" mounted	1.75 x 2.50 m	2.25 x 3.00 m	-	Plastic links	Mat can be hung up
Art. No. 20.02.125 "2000" in ground	1.75 x 2.50 m	2.25 x 3.00 m	On request	Plastic links	Folds out
Art. No. 20.02.110 XXL	1.75 x 3.00 m	2.25 x 3.50 m	On request	Plastic links	Folds out
Art. No. 20.02.108 "2012"	1.35 x 1.85 m	2.00 x 2.50 m	included	Plastic links	Mat can be hung up
Art. No. 20.02.102 "2014"	1.60 x 1.60 m	2.25 x 2.25 m	included	Plastic links	Mat can be hung up
Art. No. 20.02.121 "2017"	2.35 x 2.35 m	3.00 x 3.00 m	included	Plastic links	Mat can be hung up

Jumping equipment is not just jumping equipment

Bouncing on a trampoline – who doesn't like to do that. When designing our trampolines, we ensure that this enjoyment is not taken away from you and the jumping equipment meet the requirements of EN 1176. The design of jumping mats can have unpleasant impact on the user's well-being for example in their tension and thus jump frequency.

Therefore, in our jumping mat tension we proceed as follows: We set the tension essentially softer and gentler than is the case with many comparable pieces of equipment. In conjunction with the gradual elasticity

our mats bounce lower, slower and overall softer - thus facilitating a noticeably more comfortable bounce. We therefore warmly recommend all trampoline lovers, not to dismiss these designs as unessential and to consider these when selecting a trampoline. So that bouncing on the trampoline remains a comfortable, pleasant and enjoyable experience in the long-term.











"Rolli" Trampoline - Wheelchair Friendly

Art. No. 20.02.115, incl. dig-in frames



For symbol explanation see folding card at the back

-  3.00 x 1.75 m
Jumping area: 1.55 x 1.10 m
-  37.20 m²
-  6.35 x 5.10 m
-  1.00 m
-  3
- 
- 
- 

Movement is a good thing –

even for those with disabilities. Therefore, we have developed the "Rolli" trampoline for wheelchair users.

BENEFITS

- ⊕ incl. 2 ramps inside for easy access!
- ⊕ easy clean, simply hang up the mat
- ⊕ quick assembly without concrete
- ⊕ pre-assembled ready to play









Mini-Trampoline

Art. No. 20.02.122, for setting up with high quality wooden cladding

Art. No. 20.02.126, in ground incl. dig-in frame



For symbol explanation see folding card at the back

-  1.75 x 1.75 m
Jumping area: 1.10 x 1.10 m
-  13.75 m²
-  4.10 x 4.10 m
-  Mounted 1.40 m
In ground 1.00 m
-  5
- 
- 

Benefits

- ⊕ Easy clean, simply hang up the mat
- ⊕ Quick assembly, no concrete
- ⊕ Assembled, ready to play
- ⊕ incl. dig-in frame



"Circus" Trampoline with closed mat

Art. No. 20.02.112G, incl. dig-in frames



For symbol explanation see
folding card at the back



Ø 1.90 m
Jumping area: Ø 1.30 m



12.00 m²



Ø 4.35 m



1.00 m



2



Benefits

- ⊕ Easy clean, simply hang up the mat
- ⊕ Quick assembly, no concrete
- ⊕ Assembled, ready to play
- ⊕ incl. dig-in frame









"Circus Maximus" Trampoline

Art. No. 20.02.104, incl. dig-in frames



Hally-Gally

For symbol explanation see folding card at the back

-  Ø 2.50 m
Jumping area: Ø 1.90 m
-  22.45 m²
-  Ø 5.90 m
-  1.00 m
-  3
- 
- 

Benefits

- ⊕ Easy clean, simply hang up the mat
- ⊕ Quick assembly, no concrete
- ⊕ Assembled, ready to play
- ⊕ incl. dig-in frame



"Maximus" Trampoline

Art. No. 20.02.106, 6.00 m long, incl. dig-in frames

Art. No. 20.02.105, 9.00 m long, incl. dig-in frames









Design with separate access ramp

For symbol explanation see folding card at the back







6.00 m long

Art. No. 20.02.106

-  6.00 x 1.65 m
Jumping area: 5.34 x 0.98 m
-  37.00 m²
-  9.35 x 5.00 m
-  1.00 m
-  8
- 
- 

9.00 m long

Art. No. 20.02.105

-  9.00 x 1.65 m
Jumping area: 8.34 x 0.98 m
-  47.00 m²
-  12.35 x 5.00 m
-  1.00 m
-  10
- 
- 

Benefits

- ⊕ Easy clean, simply hang up the mat
- ⊕ Quick assembly, no concrete
- ⊕ Assembled, ready to play
- ⊕ incl. dig-in frame









"Piccolo" Trampoline

Art. No. 20.02.118, incl. dig-in frames



For symbol explanation see folding card at the back

-  1.50 x 1.50 m
Jumping area: 0.85 x 0.85 m
-  12.60 m²
-  3.85 x 3.85 m
-  1.00 m
-  1
- 
- 

Benefits

- ⊕ Easy clean, simply hang up the mat
- ⊕ Quick assembly, no concrete
- ⊕ Assembled, ready to play
- ⊕ incl. dig-in frame



"Saturn" Trampoline

Art. No. 20.02.111, incl. dig-in frames



For symbol explanation see folding card at the back



1.50 x 2.50 m
Jumping area: 2.00 x 1.00 m



26.30 m²



5.00 x 6.00 m



1.00 m



4



Benefits

- + incl. dig-in frames
- + quick assembly without concrete
- + pre-assembled ready to play







"Kangaroo" Trampoline

Art. No. 20.02.500, incl. dig-in frames



For symbol explanation see folding card at the back

	4.50 x 1.50 m Jumping area: 3.85 x 0.85 m
	31.35 m ²
	7.85 x 4.85 m
	1.00 m
	3
	
	

Benefits

- ⊕ Easy clean, simply hang up the mat
- ⊕ Quick assembly, no concrete
- ⊕ Assembled, ready to play
- ⊕ incl. dig-in frame



Trampoline 2000 – The Original

Art. No. 20.02.120, for mount with high-quality wood cladding

Art. No. 20.02.125, for installation

Art. No. 20.02.110 XXL



For symbol explanation see folding card at the back

Art. No. 20.02.120

Art. No. 20.02.125

-  3.00 x 2.25 m
Jumping area: 2.50 x 1.75 m
-  37.40 m²
-  6.50 x 5.75 m
-  1.00 m
-  8
- 

Art. No. 20.02.110 XXL

-  3.50 x 2.25 m
Jumping area: 3.00 x 1.75 m
-  40.25 m²
-  7.00 x 5.75 m
-  1.00 m
-  8
- 



Art. No. 20.02.120: Mounted version (Height approx. 45 cm) with high-quality impregnated and varnished wooden cladding.



Art. No. 20.02.120: version for assembly
Also available with a painted steel frame for an additional charge.

Dig-in frames Trampoline 2000

Art. No. 20.02.123

Art. No. 20.02.128 (for liquid fall protection)

Kit: Steel sheet frames for time-saving assembly without concrete work







Trampoline 2012

Art. No. 20.02.108, incl. dig-in frames



For symbol explanation see folding card at the back

-  2.50 x 2.00 m
Jumping area: 1.85 x 1.35 m
-  31.30 m²
-  5.85 x 5.35 m
-  1.00 m
-  4
- 
- 

Benefits

- ⊕ Quick assembly, no concrete
- ⊕ incl. dig-in frames
- ⊕ Easy clean, simply hang up the mat









Trampoline 2014

Art. No. 20.02.102, incl. dig-in frames



For symbol explanation see folding card at the back

-  2.25 x 2.25 m
Jumping area: 1.60 x 1.60 m
-  31.35 m²
-  5.60 x 5.60 m
-  1.00 m
-  4
- 
- 

Benefits

- ⊕ broken down for ease of shipping
- ⊕ for own set up on site
- ⊕ quick assembly without concrete
- ⊕ incl. dig-in frames
- ⊕ simple cleaning by hanging up mat









Trampoline 2017

Art. No. 20.02.121, incl. dig-in frames



For symbol explanation see folding card at the back

-  3.00 x 3.00 m
Jumping area: 2.35 x 2.35 m
-  40.30 m²
-  6.35 x 6.35 m
-  1.00 m
-  8
- 
- 

Benefits

- ⊕ Quick assembly, no concrete
- ⊕ incl. dig-in frames
- ⊕ Easy clean, simply hang up the mat

More colour options for safety pads and mats are available



FEEL HAPPY!





PLAYGROUND ACCESSORIES

Do your individual projects sometimes require individual accessories? Not a problem, on the following pages you will find our products which support the long-life cycle of your play equipment and the areas surrounding it. For this we have developed different detailed solutions, for example our sunshades and lawn protection mats.

PRODUCT HIGHLIGHT

Our soccer field goal goes beyond the ordinary – with our net, which allows you to practice placing the ball precisely on your own. This not only promotes individual ball control, but also makes solo training a fun and effective experience for all football enthusiasts.

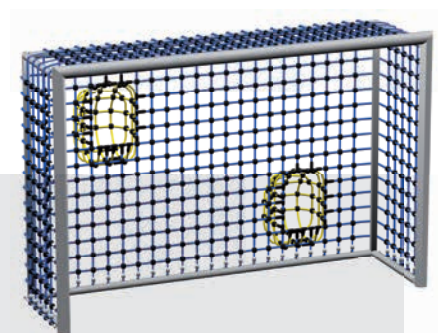
Football Goal "Goalie"
Page 210



Suspension bearings for swing seats

Page	Art. No.	Article description	Universal Joint Art. No. 4608	Universal Joint incl. safety bearing Art. No. 4608-1	Safety Bearing Art. No. 4608-5	Swing Bearing Art. No. 4602	Swing Bearing, reinforced version Art. No. 4608-3	Bearing for Mini-M-Swing Art. No. 4602M	Bearing for Mini-M-Swing, robinia wood posts Art. No. 4602M-R	Swing Bearing with swivel rotating effect Art. No. 4608-4	Swing Bearing with swivel rotating effect Art. No. 4608-2
			Page 205	Page 205	Page 205	Page 206	Page 206	Page 206	Page 206	Page 207	Page 207
146	4650	Original HUCK Bird's Nest		x							
148	4650-85	Original HUCK Mini Bird's Nest		x							
148	4550	Original HUCK Honeycomb Nest		x							
148	4650-85M	Original HUCK Mini Bird's Nest for Mini-M-Swing						x	x		
153	4712	Safety Swing Seat with chain				x	x				
153	5720-1	Swing Seat with chain				x	x				
153	4700-08	Rustic Board Swing				x	x				
153	491	Pendulum Seat with chain								x	x
153	4698-1	Simple Tyre Swing				x	x				
153	4693-10	Baby Seat				x	x				
153	4693	Toddler Swing Seat				x	x				
153	4693-70	Double Toddler Swing				x	x				
154	4610	Climbing Chimney									x
154	4611	Climbing Chimney									x
154	4620	Rope Ring Swing Carousel									x
154	4630	Oval Rope Swing				x	x				
154	4695	Swing Seat Maxi					x				
154	4695-30	Swing Seat Midi					x				
154	4696	Swing Seat Mini					x				
155	4771-08	Partner Swing "Rustikal"				x	x				
155	4772-08	Trio Swing				x	x				
155	4585-40	Rope-end Swing		x							
155	4770-08-200/250	Jungle Rope Swing	x								
155	4651-20	Swing Bed		x							
156	806	Hammocks (with links and steel rope)								x	x
156	807	Hammocks Band								x	x
161	808	Hammock made from Hercules rope and knot balls								x	x
157	808VA	Hammock made from Hercules rope and knot clips								x	x
158	807-200	Hammock made from polyester								x	x
162	808-1	XXL Resting Hammocks								x	x



Universal Joint

incl. safety bearing for Bird's Nest swing

Art. No. 4608-1

Equipment

For hanging heavy suspended swings
(e.g. Original HUCK Bird's Nest)

With PA bearing and additional Teflon bush

Bolt - Universal Joint M18 x 220 mm,
Bolt - safety bearing M16 x 200 mm, red

With additional safety bearing and chain specifically
for hanging the Original HUCK Bird's Nest



Universal Joint for Bird's Nest swing

Art. No. 4608

Equipment

Bolts M18 x 200 mm, galvanized, red or black powder-coated

Bearing with polyamide bush and additional Teflon bush

Designed for both hook directions



Safety Bearing

with chain for Bird's Nest swing

Art. No. 4608-5

Equipment

Bolts M16 x 200 mm, galvanized, red or black powder-coated

Bearing with polyamide bush

Designed for one swing direction



Bearing for Mini-M-Swing

Art. No. 4602M

Art. No. 4602M-R, robinia wood posts

Equipment 4602M

Bolts M12 x 120 mm, galvanized, red powder-coated

With stainless steel shackle M8

Bearing with polyamide bush

Design for both swing directions

Equipment 4602M-R

Bolts M16 x 200 mm, galvanized, red powder-coated

With stainless steel shackle M8

Bearing with polyamide bush

Designed for both swinging directions



Swing Bearing reinforced version

Art. No. 4608-3

Equipment

Bolt M16 x 200 mm, galvanized, red

Bearing with polyamide bush

Designed for one swinging direction



Swing Bearing

Art. No. 4602

Equipment

Bolt M12 x 200 mm, galvanized

With PA socket with stainless steel shackle M8



Swing Bearing for Hammocks with swivel rotating effect

Art. No. 4608-4

Equipment

Bolts M16 x 200 mm, galvanized, red-powder-coated

With stainless steel shackle M8 and stainless-steel
swivel with fork head

Bearing with polyamide bush

Designed for both swinging directions

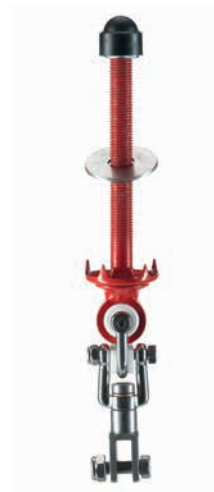

Shackle rotating swivel M8

Art. No. 4603 with Teflon bearing, stainless steel



Swing Bearing with swivel made of VA (ball bearings)

Art. No. 4608-2

to accommodate an 8 mm chain





Net and rope connectors for Robinia posts

Plates for chain coupling

including screws

Art. No. 4575-01-VA

Set to attach to post

Equipment

1 x stainless steel slotted disc (Ø 60 mm)

1 x stainless steel perforated disc (Ø 60 mm)

4 x pan head screw 5.50 x 19 mm

1 x button head screw 5.50 x 42 mm



Chain Shackle M8

incl. chain

Art. No. 4575-02-VA

set to attach to post

Equipment

1 x VA chain 6 mm, length 50 cm

1 x VA chain shackle M8 (Art. No. 440-30)



Further information on our Robinia posts can be found on Page 14

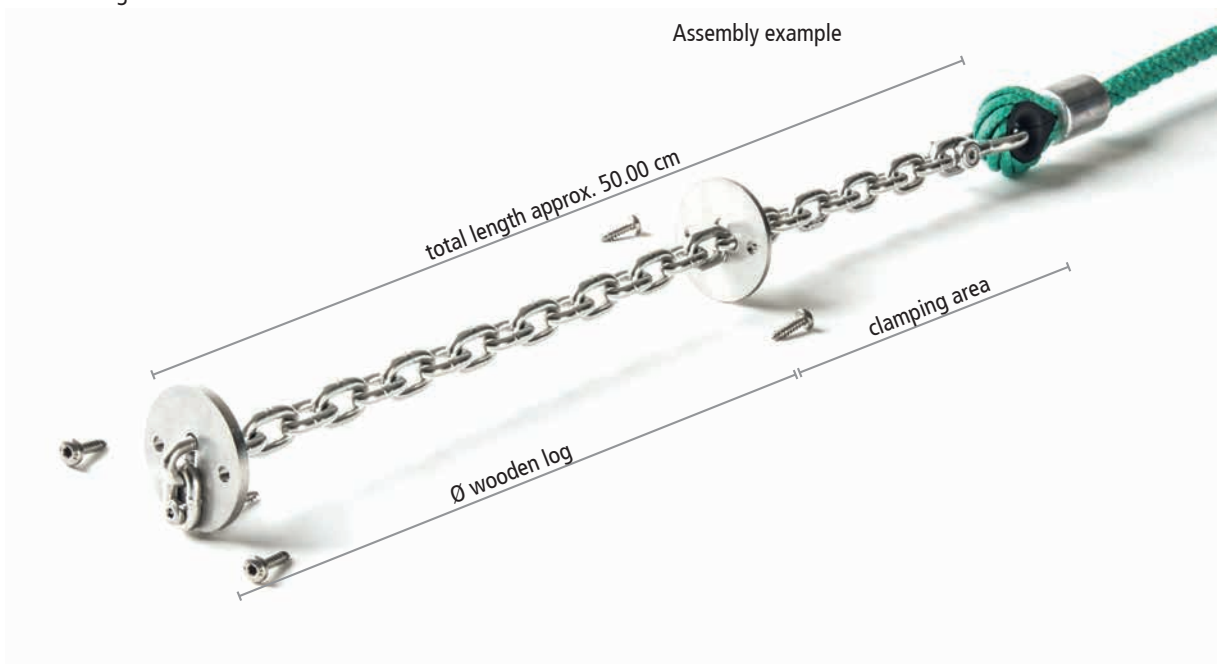



Maintenance and Repair Sets for Original HUCK Bird's Nests

Repair Kit for Bird's Nest base

Art. No. 4650-30

Equipment

1 unit PA-coated wire cable, 3/4.5 mm, 5 running metres

30 units plastic links (20 units wide, 10 units. narrow)

10 units high-alloyed screw connector

20 units raised head with Torx and safety pin M5 x 10 mm

1 manual



Repair Kit for Bird's Nest rope wrapping

Art. No. 4650-31

Equipment

1 unit shrink ring, black width 50 mm –
0.4 running metres - incl. adhesive patch

1 roll of adhesive patch, 50 mm wide,
white approx. 1.5 running metres

2 units hose clip (Ø 90 - 110 mm)

1 unit foam film

1 manual



Suspension Chain Set for Bird's Nest Swing

Art. No. 4650-20

Equipment

With chain sleeve

Hose colour: red or black

universal for suspension level of 2.00 m to 2.60 m



Suspension Ropes for Bird's Nest Swing

Art. No. 4650-10

Equipment

Rope colors: black, fluorescent orange, hemp-colored, grey, red,
fuchsia, blue, yellow, green, turquoise, rust

universal for suspension level 2.00 m to 2.60 m



Our Original Huck Bird's Nest
can be found on Page 146





Sport, play and leisure-time

Football Goal "Goalie"

Art. No. 4666-130 Mesh size 13 x 13 cm

Art. No. 4666-130-K Mesh size 13 x 13 cm, with 2 goal baskets

Art. No. 4666-230 Mesh size 23 x 23 cm

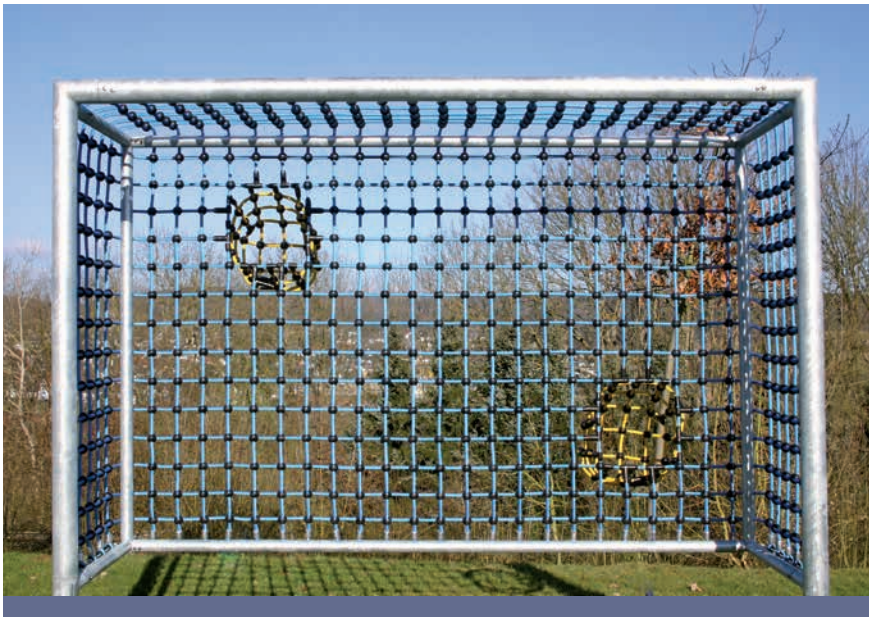

Equipment

Steel goal frames (Ø 102/76 mm), hot-dip galvanized, to be set in concrete

2 ground anchor screws for a stability for concreting in

Net made from Hercules rope (Ø 16 mm, 6-strand, with steel core), Colour: 04 blue

2 goal wall baskets (60 x 60 cm) made from Hercules rope (Ø 16 mm, 6-strand, with steel core), Colour: 05 yellow

Technical data

Length: 3.20 m

Depth: 1.00 m

Height: 2.15 m



Tested according to DIN EN 15312

A strong goal: Our HUCK football area goals – designed for football and handball – withstand maximum stress. We therefore provide you with a 15-year guarantee for the steel frame. We also offer a price-conscious option with bigger mesh-size.

Simply speak to us!

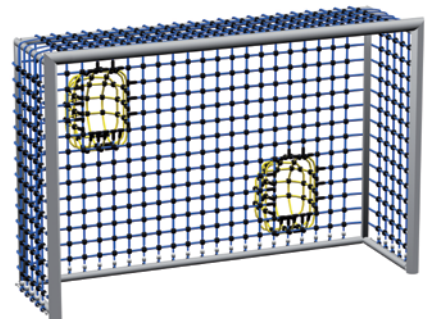

On request, special version available too in other net sizes – 2.00 x 1.50 m (length x height), depth 0.90 m



Football Goal "Goalie Sport"

Art. No. 4665



Equipment

Steel goal frame (Ø 102/76 mm), hot-dip galvanized, for a surcharge also available painted

2 ground anchor screws for a stability for concreting in

Net made from Hercules rope (Ø 8 mm, 3-strand with steel core), Colour: black

HUCK knot system, colour: black

Technical data

Length: 3.20 m

Depth: 1.00 m

Height: 2.15 m



Tested according to DIN EN 15312

Freely accessible multi-sports equipment

The "Goalie Sport" frame is identical to the "Goalie" frame:

STRONG – STURDY – DURABLE

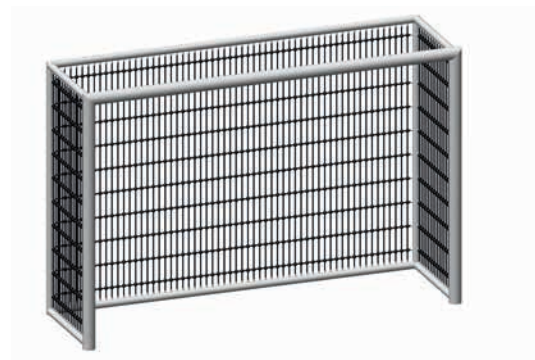



Football Goal Net "Dralo"

Art. No. 4064



Equipment

Steel wire rope (Ø 3 mm), galvanized

Mesh size approx. 10 cm, square mesh design

Incl. anti-theft rope assembly kit

Goal frame not included!

Technical data

Length: 3.00 m

Depth: top 0.90 m, bottom 0.90 m

Height: 2.00 m



Tested according to DIN EN 15312



Football Goal Net "Clips-Version"

Art. No. 4664

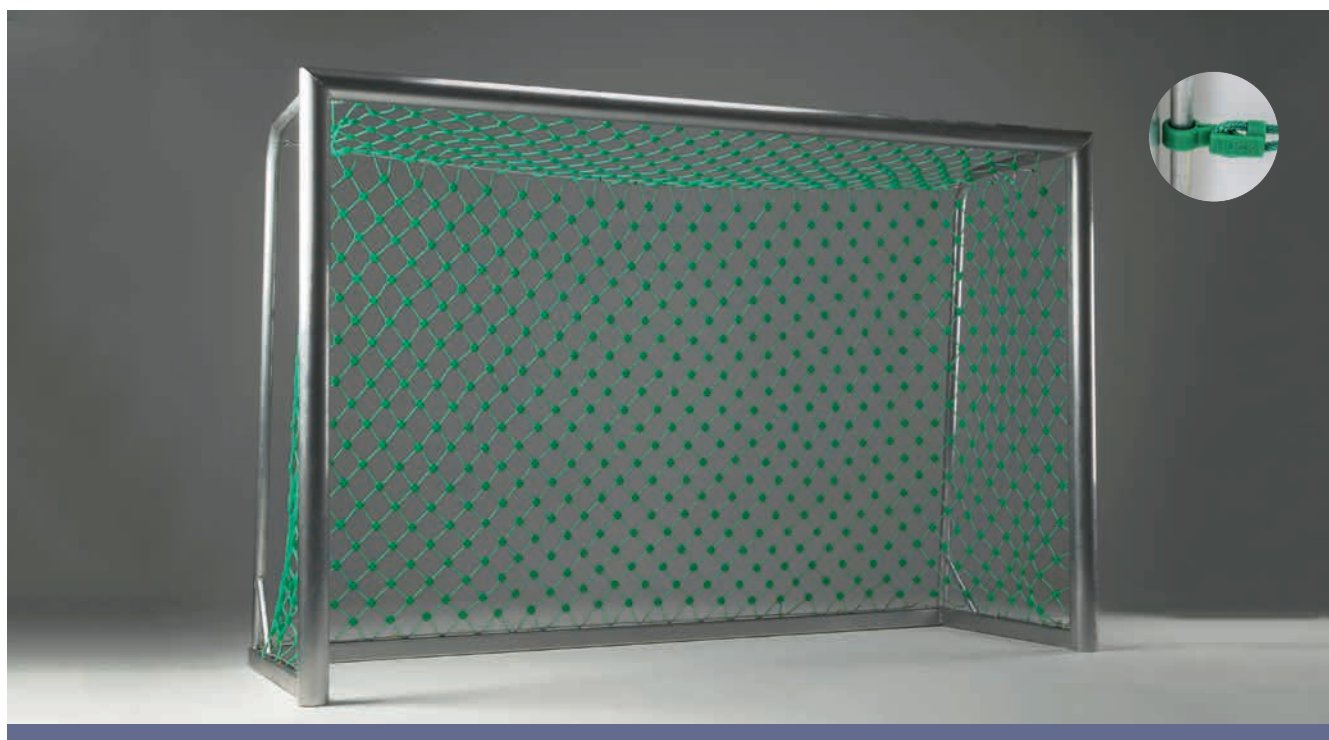

Equipment

Clip net made of Hercules rope (PES-coated, Ø 5 mm), suitable for handball goals

with net hoop mesh size 10 cm, diagonal stitches, green, black, beige

Goal frame not included!

Technical data

Length: 3.00 m

Depth: 0.90 m

Height: 2.00 m



Tested according to DIN EN 15312

SIGNIFICANTLY IMPROVED!

With additional scoring protection in the outer area made from high-quality polyamide loops!

ASSEMBLY INSTRUCTIONS

Always hang the goal net inside the goal frame.
Never pull the net over the frame!

⊕ Rope design: PES-coated, green, black or beige

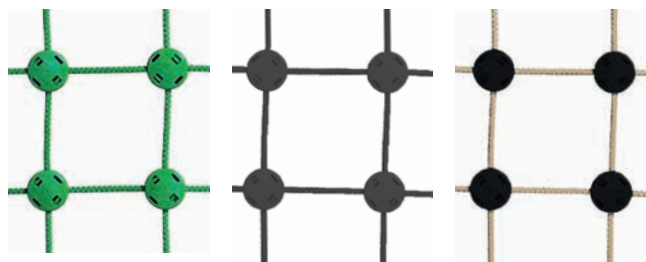



Ball stop fence nets

Multi-functional play facilities have an important social function in residential areas. They are a place where young people can be active together in a sporty way without the fear of smashing a windowpane or suchlike. Equipped with anti-vandal sport nets these facilities offer high quality with long service, plus increasing the living quality of residents.

When used as an anti-vandal ball stop net the HUCK clips net made from Hercules rope achieve better sound-proofing properties than a mesh wire or steel grating fence measured in accordance with DIN EN ISO 11202.

Hercules-Clips net

The 2,50 mm polyester coated wire rope is connected to a square mesh net using a plastic knot connecting system. The coating provides for a durable and attractive surface.

Dralo wire rope net

Dralo is the wire rope net in the HUCK range with a decent design, which despite this can only be destroyed with extreme force. At the same time the rope net emanates less noise upon ball contact.

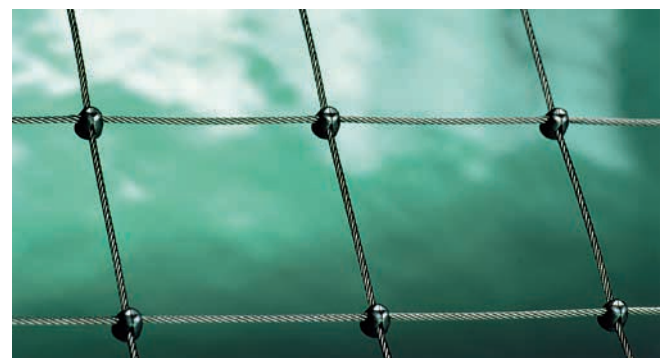
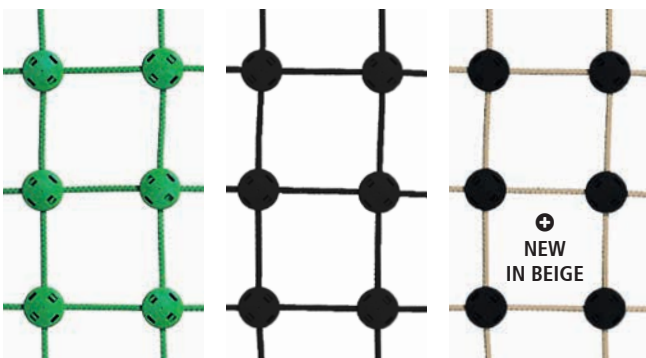

- ⊕ Rope design: PES-coated, green, black or beige
- ⊕ Rope thickness: 5 mm (Wire strand 2.5 mm Ø)
- ⊕ Mesh size: 50, 100 mm (rhombic)
- ⊕ Knot connection: plastic clips (green or black)
- ⊕ Mesh strength: approx. 0.5 kN
- ⊕ Vandal-proof level: average

- ⊕ Rope design: galvanized or stainless steel
- ⊕ Rope thickness: 1.5 mm bis 5.00 mm
- ⊕ Mesh size: 25 to 200, 50 x 100, 50 x 200 mm
- ⊕ Knot connection: Aluminium or stainless-steel clips
- ⊕ Mesh strength: approx. 0.8 – 3.5 kN
- ⊕ Vandal-proof level: high





HUCK Dralo Ball stop fence modular system

The silent ball stop net

Our basic module has a standard width and height of 5 metres each, but this can be quite simply made bigger with other modules (also 5 x 5 metres in size).

The basic module includes two posts, a net incl. crossbar for the top closure, the necessary tensioning piece and assembly accessories. If you order additional modules, we supply another post, the net and all necessary small components.

The tension puller developed especially for this module system (top) facilitates a light cross-profile for maximal stability. This then creates a visually pleasing, straight finish to the wire rope net.

The assembly of the net fields (net + crossbar) can be easily managed by one person in a mobile elevating platform. The system can be efficiently assembled and contains durable, vandal-proof components.

With the formation of different mesh sizes (below 50 x 100 mm, from 2 m height, 50 x 200 mm climbing the fence is supposed to be prevented at the same time as saving weight. Pursuant to DIN EN 15312 the horizontal mesh size of ball stop nets must not exceed 50 mm, to make it difficult to climb.

Ball Stop Fence "Dralo" basic module

Art. No. 46500 Width: 5.00 m, Height: 5.00 m

Equipment

2 Posts (1x 6.00 m, 1x 6.50 m)

1 Dralo Net (5.00 x 5.00 m) incl. crossbar

Tensioning rope

Fastening accessories



Ball Stop Fence "Dralo" add-on module

Art. No. 46500-1 Width: 5.00 m, Height: 5.00 m

Equipment

1 Post 6.00 m or 6.50 m

(6.00 and 6.50 m can always be alternated)

Fastening accessories

Ball Stop Fence "Dralo" 90° corner module

Art. No. 46500-2

Equipment

90° angle

⊕ SILENT BALL STOP NET

because of strong connection of the net knots

⊕ VANDAL PROOF

With the use of a steel rope net

⊕ EASY ASSEMBLY

Due to handy module size

Net height from 2.00 m
mesh size 50 x 200 mm.
This low-cost mesh size is perfectly sufficient for balls.

For net heights up to 2.00 m
mesh size 50 x 100 mm.
This mesh size is difficult to climb.

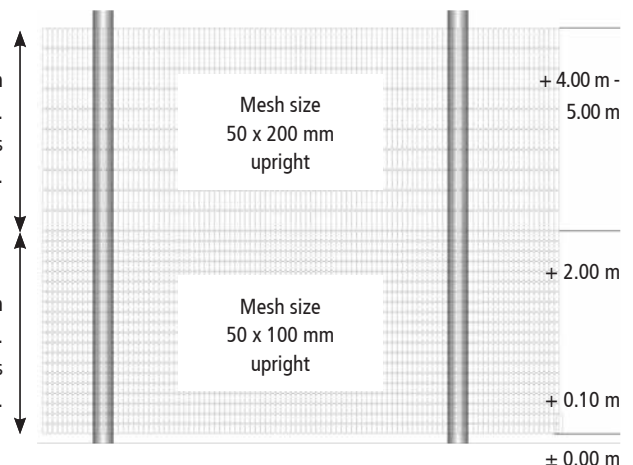



Basketball "Hercules-Clips-Net" single

- Art. No. 4677-2 – Rope green/Clips green
- Art. No. 4677-2-06 – Rope black/Clips black
- Art. No. 4677-2-C01S06 – Rope black/Clips green
- Art. No. 4677-2-C06S08 – Rope cream/Clips black



ANTI-THEFT PROTECTION!

For end fastening the clamps are pushed up the whole way and closed. This secures the net and protects it from theft!

1000 TIMES PROVEN!

Equipment

Clip net made of Hercules rope (PES-coated, Ø 5 mm, with steel core) suitable for every standard basket available on the market (not available from HUCK), theft-proof assembly thanks to integrated clamps

Noise reduction compared to chains



Art. No. 4677-2
Rope green/
Clips green



Art. No. 4677-2-06
Rope black/
Clips black

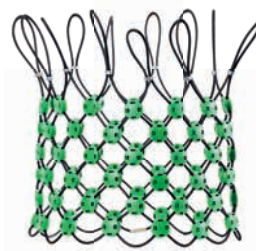

Art. No. 4677-2-C01S06
Rope black/
Clips green



Art. No. 4677-2-C06S08
Rope cream/
Clips black

Volleyball Net "Hercules-Clips-Net"

Art. No. 4674-1 without posts (available as an option)

Equipment

(Ø ca. 2.5/5 mm) Mesh size 100 mm

Net size 1.00 x 9.50 m (international provision), Colour green

Volleyball Net in "Dralo"

Art. No. 4674-10 without posts (available as an option)

Equipment

Steel wire rope (Dralo) (Ø 2 mm), galvanized, mesh size 100 mm

Net size 1.00 x 9.50 m (international provision)

Edging made from 160 mm wide coated fabric with "HUCK" printing

For use with standard volleyball posts



The tear-proof volleyball net in attractive design – fits all standard volleyball posts.





Sun sails



Possible shapes



For special shapes and larger sails, we recommend the sun sail material with a shade of 90:10 (320g/m²). Please contact us for professional advice!

Shade 50:50 (200g/m²):

orange, blue, red, light green, dark green, silver, terracotta, cream



Shade 90:10 (320g/m²):

blue, dark green, silver, cream

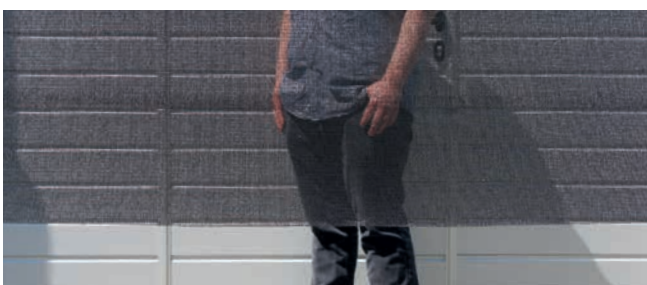



Sun Pavilion Cover Combination

Art. No. 5782-1-04 without ground sleeves

Art. No. 5782-2-04 with ground sleeves



Equipment

Awning made from water-permeable and breathable fabric (blue, other colours on request)

Incl. hot-dipped galvanized steel pipes (Ø 76 mm)

With lashing strap for height adjustment

Shade 50:50

Available with or without ground sleeves

Technical data

Size: 5.50 x 5.50 m

Necessary basic measurements:
6.90 x 6.90 m

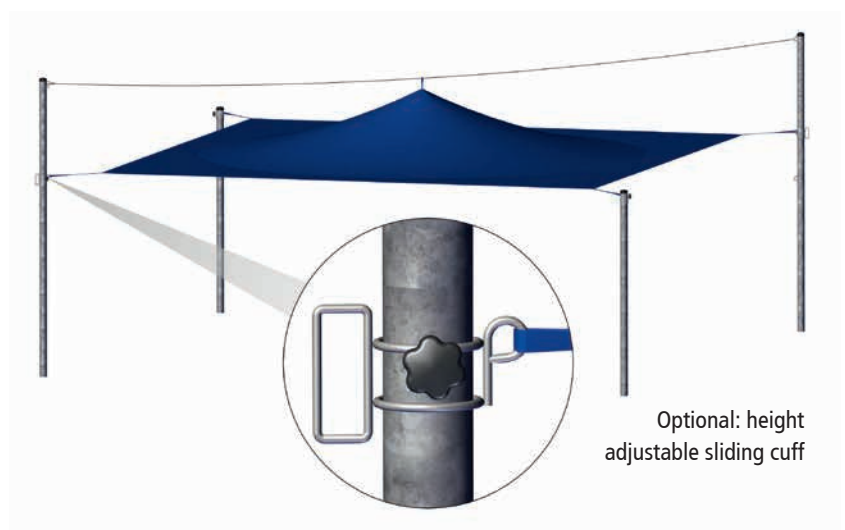

Optional: height adjustable sliding cuff

Slip-on Sleeve (stainless steel)

Art. No. 5785 one unit per post

Equipment

With handle opening and eyelets

Steel thickness 8 mm,
for 76 mm Ø – Steel posts



SIMPLY CLEVER!

Suitable for posts Ø 76 mm in diameter, the slip-on sleeves can be adjusted to any height and automatically fixed through the anchor. Create a simple connection between posts and sail.

Not suitable for powder-coated or painted posts

Tension Belt

Art. No. 5502-025

orange, cream, black,
silver, red, blue, dark green



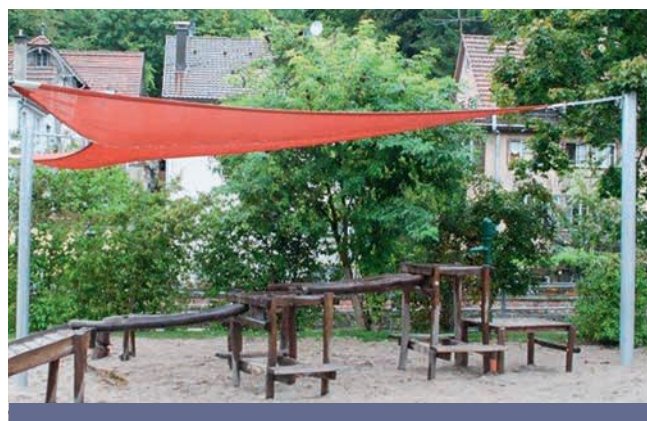



Sandpit Cover

Art. No. 720, Size as requested



Equipment

Air and water permeable synthetic fabric, UV resistant cover colours blue, red, light green, dark green, orange, silver, terracotta, cream

With reinforced edges and cover eyelets
(Distance 0.50 m between each one)



Rubber Edging Cord

Art. No. 2126

Equipment

Ø 6 mm, white with identification stripe

Recommended fastening: PE buttons Art. No. 720-1

NO CONTAMINATION

➔ animal excrement, foliage, falling leaves

ORDER WITHOUT OVERHANG
Please specify sandpit dimensions.

ORDER WITH OVERHANG
Please specify desired final measurements of the cover/net.
Usually an overhang of 20 cm on each side.



PE Buttons

Art. No. 720-1 Set of 10

Equipment

With stainless steel screws and distance sleeves to hang the rubber edging cord

Recommendation: spaced every 60 cm





Lawn Protection Mats

20 years of experience speaks for itself

As soon as play area grass is frequently used, it gets worn away from time to time. It can be that stones protrude, which increase the risk of an accident for children. When it is wet, they slip over and when it is dry the impact is no longer gentle but instead quite painful. Neither does the grass grow back quickly at these spots.

That's why we recommend our lawn protection mats to you. They protect meadows and children alike. The mats almost come part of the ground and can also be placed down subsequently without any problems. Moreover, a gentler fall for children and they are not so quick to slip over. With these beneficial properties our lawn protection mats mean that children can let off steam in any weather.



Mats approx. 4-5 weeks after assembly

Lawn Protection Screen Mats

Art. No. 4656

Description

Plastic-coated, close-meshed chain-link mats, abrasion proof, UV resistant, can be mowed over

Thickness approx. 2 mm, fixed width 5.00 m (Roll goods), can be cut to any size, larger areas can be made bigger if required

Colour: 06 black

Easy assembly by burying in the boundary area

IN USE FOR 20 YEARS

Low-cost protection in closed facilities

- ⊕ non-slip
- ⊕ easy to assemble





Slope stabilisation roll chain-link mats

The solution for hills that are played on:

Do you know that costly steps are built next to hillside slopes of less than - 1.00 m, which often go unused. Instead the climb directly next to the slide is used and worn away by children playing.

Protect the ground and slopes in strongly used areas (e.g. directly next to slides) in a sustainable and inexpensive way! Our roll chain-link mat is exactly the right thing for you here!

We produce these from the rubber elements from our Hally-Gally trampoline range, which have been tried and tested for 30 years now. They adapt to the terrain, are flexible, cushion falls and can be fixed into the ground with anchor chains.

Cover the mats evenly with mulch or sow grass – playtime does not even have to be interrupted for this. Neither are washed or worn away during play.

HAVE A QUOTE DRAWN UP!

- ⊕ any length
- ⊕ any width, up to max 2.00 m per segment
- ⊕ "joining" possible
- ⊕ segments possible

YOUR BENEFITS

- ⊕ cost efficient
- ⊕ quick to assemble
- ⊕ non-slip
- ⊕ no wearing away effect through play
- ⊕ Segments possible
- ⊕ with pre-mounted anchor chains

Explanatory notes on the tested drop heights Relating to lawn protection mats and roll chain-link mats

- ➔ Our lawn protection mat was tested according to DIN EN 1177 according to international laboratory conditions and has theoretically approval for a fall height of 70 cm for use on concrete floors.
- ➔ In addition, testing was carried out on site on a grass area in accordance with DIN EN 1177 Para. 4.7.3. The drop height ascertained here exceeded the values of the test on concrete by a lot as expected.
- ➔ In theory a value of only around 377 HIC was determined for a maximal drop height on grass (1.50 m).
- ➔ Maximum allowed would be 1000 HIC.



Mat directly after placing



Small hole in ground for anchor chains + point foundation (ca. Ø 5.00 cm)



Lawn protection mats after installation (laid open for photo)





Bollards

For the natural boundary of water areas, pathways, meadows etc. Quick and low-cost assembly. PP rope is only destructible using extreme force thanks to its steel wire. The "hemp" colour is harmonious in urban design. The recommended spacing between posts is 2.50 m to 3.00 m.

The rope is pulled through the posts on site for the entire length required. To prevent the rope from slipping, it is then fixed to each post using an internal sleeve.



PP-Rope with steel core
per running metre Art. No. 4990-08

Description

Ø 65 mm

With steel core (Ø 10 mm)

Rope colour: hemp coloured



Fixing Sleeves
Art. No. 4990-10

Description

For attaching on the inside

Please note: 2 sleeves are required for end bollards!



Middle Bollard with 1 drill hole
Art. No. 4990-4-10

Description

Sanded Douglas fir posts, core separated, pressure-treated

Ø 16 cm, length 1.50 m, without fixing bushes



End Bollard with 2 drill holes
Art. No. 4990-5-10

Description

Sanded Douglas fir posts, core separated, pressure-treated

Ø 16 cm, length 1.50 m, without fixing bushes





GREAT JOB!



REFERENCES

Whenever the large variety of our HUCK catalogue is just not enough, we can realise individual solutions customised for your project and its specific requirements, thus offering you a tailor-made service! On the following pages you will find individual customer solutions which we have designed, produced and assembled. Using our know-how and our many years of experience in designing play rope equipment we create the perfect experience for your indoor or outdoor projects. Because we know what matters.

FURTHER PRODUCT HIGHLIGHTS

Immerse yourself in our world of playground equipment! Follow us on social media or our website and be inspired by inspiring ideas and references.





Pit Fortuna Bird's Nest Tower "Black Forest"



Take the next climbing step, reach the highest platform for the first time, dare to go back on the slide, let your mind wander for a short moment - or simply spend time together with friends: On our Black Forest climbing tower at the Fortuna pit in Berghausen, children have the choice - they can develop freely, let off steam all around, get better and better at climbing and make new friends at the same time.



© lichtwerk | christian plaum



Herborn Game Reserve 6-Corner Tower & Bird's Nest Tree "Eagle's Nest"



Fun in any weather. Safe climbing fun is always the top priority at Huck Seiltechnik. In the Herborn Wildlife Park, you can climb high up and get a bird's eye view of the zoo. A unique experience.



© lichtwerk | christian plaum



Adventure tower in the Bürger- und Miniaturenpark Wernigerode

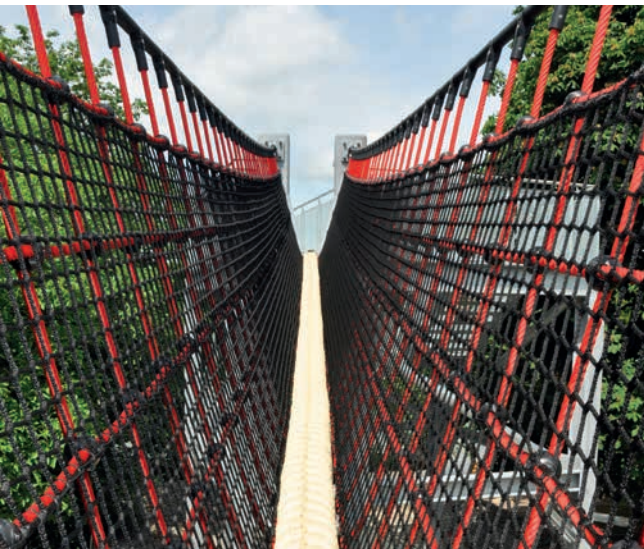

A wooden catwalk bridge and a jungle bridge – the perfect combination for leisure fun with the whole family. In the Bürger- und Miniaturenpark Wernigerode, young and old get their money's worth.



Bird's Nest Tree Combination with Connecting Bridge in Fiss-Ladis, Austria



Powder-coated steel parts and a play paradise in black can be found in Fiss-Ladis. With its special design, this impressive piece of playground equipment blends wonderfully into the rugged mountain world.

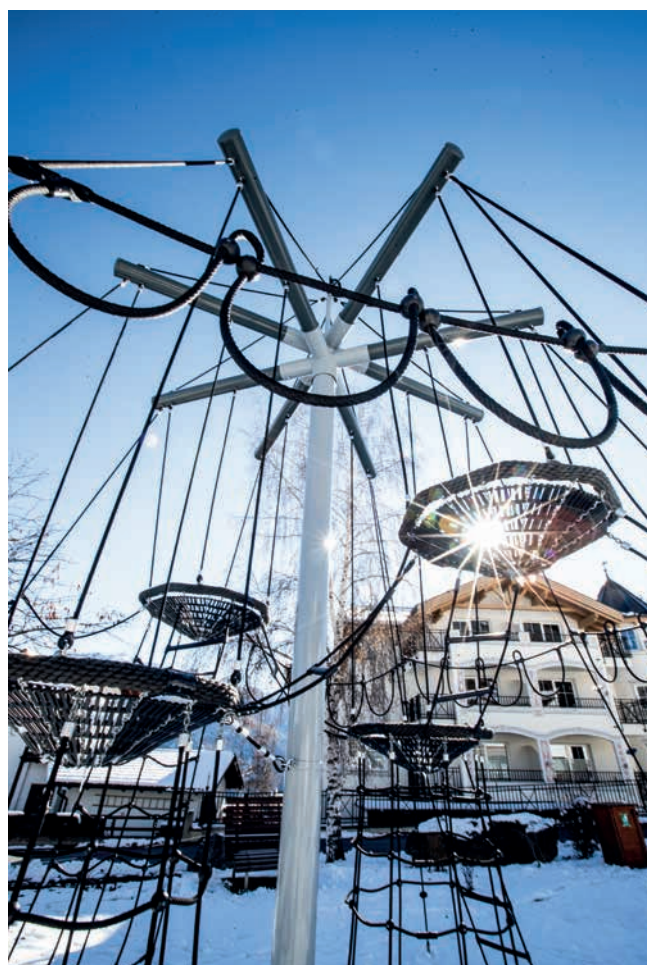



Balancing Snake

A playground according to customer requirements

The requirements of the city of Haan when they contacted us about a new project were clear: they wanted a play area that offered children a lot and encouraged them to play together. During development, we brought in all our experience and also took into account the technical possibilities as well as current standard specifications.

In the end, the ideas resulted in a playground device in the shape of a snake that is as special as any child who can let their imagination run wild here.

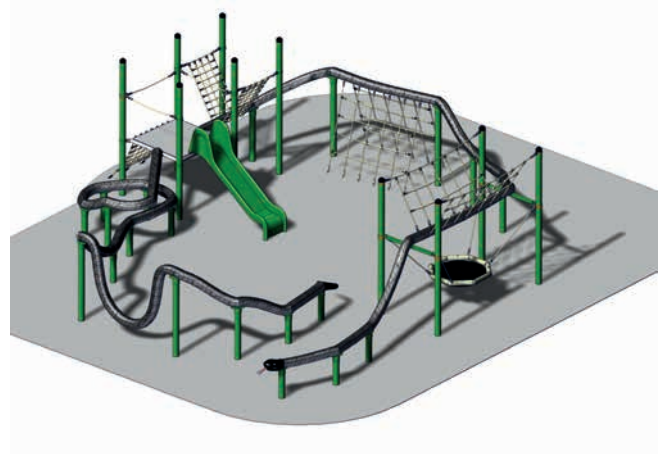

The HUCK group

www.huck.net

INDUSTRIAL NETS

CONSTRUCTION PROTECTION NETS

SPORTS NETS AND ROPES

We offer nets for technology and the environment, be it for lifting, lashing, loading or covering. Our product range also includes personal safety nets, scaffolding protection nets, side protection nets and goal nets, as well as ball stop nets that meet the highest standards and are EN certified and comply with BG rules. If required, we also rent out our scaffolding protection nets. Whether you are involved in recreational sports or ball sports, you will find the right solutions with us.

Feel free to request our catalogues at www.huck.net

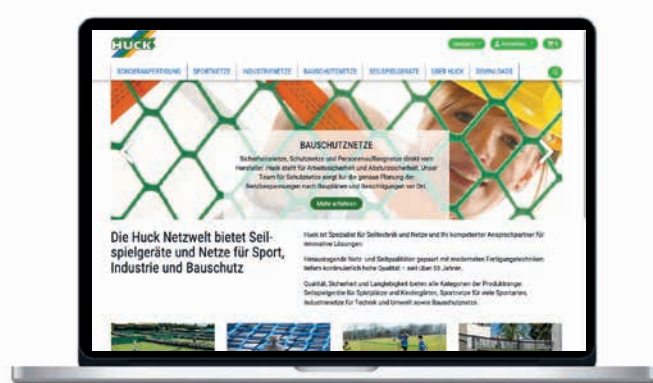

www.huck-spielgeraete.de
PLANNING, ORDERING, RESEARCHING

We showcase all our products on our website with brief descriptions, photographs and diagrams. You will also find assembly instructions and TÜV certificates. So, you can take measurements in peace and quiet and plan your projects. Browse through our current catalogues and keep up to date with our news. You'll strike gold here!

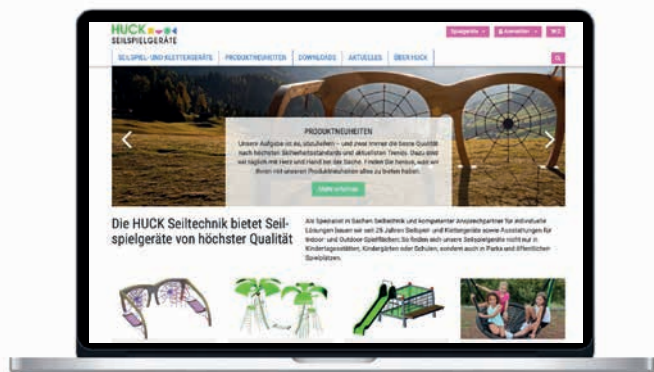

SOCIAL MEDIA – FOLLOW, GET INFORMATION, LIKE
Follow us on the social platforms, read and like our articles and experience it closely with us e.g. the current installation of new equipment or our trade fair attendance.



MEMBER OF



www.bsfh.info



www.ipema.org



List of keywords

3-part Ladder "Fun course" 122

A

Adventure Honeycomb Nest 36
Adventure Tunnel "Fun course" 122
Aerial Runway, with buried ground anchor 92
Anaconda Maxi 62
Arc Bridge "Fun course" 122
Arc Rope "Haiger" 118
Arch Swing to set in concrete 143
Attachment to posts and beams 130

B

Balancing Rope "Haiger" 118
Ball Stop Fence "Dralo" 215
Band Hammock 156
Bar, single "Haiger" 119
Basketball "Hercules-Clips-Net" single 216
Bearing for Mini-M-Swing 206
Bird's Nest "Chill Out" XXL 163
Bird's Nest Carousel, spinning 54
Bird's Nest Tower "Black Forest"-Combi.. 103
Bird's Nest Tower "Black Forest" 106, 107
Bird's Nest Tower, with steel posts 104
Bird's Nest Tower, with wood posts 105
Bird's Nest Tree 97
Bird's Nest Tree "Drago" 96
Bird's Nest Tree "Laola" 99
Bird's Nest Tree Midi 102
Bird's Nest Tree 100, 101
"Black Beard" Pirate Ship 88
Bow Net 78
Bridge "Fun course" 122

C

Chain Shackle M8 incl. chain 208
Cheops-Combination Midi 173
Cheops-Pyramid Maxi 171
Cheops-Pyramid Midi 172
Cheops-Pyramid Mini 174
"Circus Maximus" Trampoline 193
"Circus" Trampoline with closed mat 192
Climb and Chill 82
Climbing Bench 46
Climbing Equipment "Colour mix" 45
Climbing Glasses 81
Climbing Net "Dillenburg" 119
Climbing Net "Haiger" 118
Climbing Nets 128-129
Climbing Palm 83
Climbing ropes 133
Climbing Rungs "Haiger" 118
Climbing Whirl, spinning 84
Cyclops Swinger, 4-seater, single 112

D

Deep Space Net Pyramid 185
Diablo, spinning 52
Double-sided connections
for climbing ropes 133
Dragon Swinger 109
Dralo wire rope net 214

E

Eagles Nest Platform 70
Eagles Nest Tree 98
Earthworm Mini 63
Easy-Climb 1 42
Easy-Climb 4 43
Easy-Swing "Honeycomb Nest" 149
Easy-Swing "Maxi" 151
Easy-Swing "Midi" 151
Easy-Swing "Swing Bed" 150
Ellipsis, spinning 76
End Bollard with 2 drill holes 223

F

Fixing Sleeves 223
Floating Mats 60
Football Goal "Goalie Sport" 211
Football Goal "Goalie" 210
Football Goal Net "Clips-Version" 213
Football Goal Net "Dralo" 212
"Fortuna" Bird's Nest Tower 26
"Fortuna" Mini Pirate Tower 22
"Fortuna" Play Course 31

G

Gondolar Swinger 111
Green Mamba 63

H

"Haiger" Inclusion Equipment 21
Hammock Trio 159
Hanging Rope "Dillenburg" 119
Hanging Rope "Haiger" 118
Hercules Climbing rope 133
Hercules Rope Hammock with clip fixings 157
Hercules Rope Hammock with cross-stitch 157
Hercules Rope Hammock
with plastic knotballs 161
Hercules-Clips net 214
Hexagon Tower 80
Holding Loops "Haiger" 119
Holding Rings "Haiger" 119
Hourglass 91
HUCK climbing chimney 138
HUCK Net Tunnel 138
Hydra Swinger, 4-seater, double 113

I

Inclusive Track 9, 222

J

Jungle Bridge per running metre 137
"Junior" Play Ship 24

K

"Kangaroo" Trampoline 197

L

Ladders 135
Lantern Climbing Nest 48
Lantern Swing Nest 48
Large Climbing Pyramid, spinning 86
Liana Swing, spinning 49
Little Eagle's Nest 40
Little Eagle's Nest Carousel 39
Loop Bridge "Fun course" 122
Loops/Rings 134

M

Maxi Hexagonal Climbing Castle 32
"Maximus" Trampoline 194
Meeting-Point 50
Middle Bollard with 1 drill hole 223
Midi Climbing Tepee 85
Midi-Climbing Whirl, spinning 51
Mikaado 1000 6
Mikaado 2000 6
Mini Bird's Nest Carousel, spinning 54
Mini Bird's Nest Tree 25
Mini Climbing Pyramid, spinning 51
Mini Pirate Tower 59
Mini Rope-End Swinger 35
Mini-M Slide 44
Mini-M-Swing 152
Mini-Trampoline 191
Mushroom Carousel 58

N

Nest Carousel, spinning 55
Net bridge in V-Form 136
Net bridge 136
Net bridges 139
Net handrails 136
Net Seesaw with steel 57
Net Seesaw with wood 56
Net tunnels 139

O

Olive Tree 87
Original HUCK Bird's Nest 146
Original HUCK Bird's Nest on springs 38



Original HUCK Bird's Nest Sombrero.....	5	Small Discs "Fun course"	122
Original HUCK Honeycomb Nest.....	148	Space Capsule, spinning	90
Original HUCK Mini Bird's Nest.....	148	Sparrow's Nest with slide	23
P		SPIDER 4 Pyramid with 4 guy lines	167
PE Buttons	220	SPIDER 6 Pyramid with 4 guy lines	168
"Piccolo" Trampoline.....	195	SPIDER 6 Pyramid with 6 guy lines	169
Pirate Tower.....	89	SPIDER 8 Pyramid with 6 guy lines	170
Plastic Link Hammock	156	Spider Web.....	61
Plates for chain coupling.....	208	Spinning Mushroom.....	77
Play Cube with slide.....	47	Spiral Carousel, spinning.....	55
Polyester Hammock	158	Spring-mounted Balancing Lines.....	66
Polyester Hammock "Haiger"	118	Stainless steel fixings and connectors 131-132	
Possible Ladder fixings.....	135	Steel posts.....	123
PP-Climbing rope	133	Sun Pavilion Cover Combination.....	218
PP-Rope with steel core	223	Sun sails.....	217
PP-Walkway rope.....	137	Super-Climb Maxi	182
R		Super-Climb Midi	183
Repair Kit for Bird's Nest base	209	Super-Climb Mini	183
Repair Kit for Bird's Nest rope wrapping...209		Surfer "Haiger"	119
Robinia posts	123	Suspension Chain Set	
"Rolli" Trampoline, Wheelchair Friendly...190		for Bird's Nest Swing	209
Rope Ladder "Haiger"	118	Suspension Ropes for Bird's Nest Swing ...209	
Rope Ladder Rungs "Haiger".....	118	Swing Bearing.....	206
Rope Net Pyramid DINO 1.....	178	Swing Bearing for Hammocks	
Rope Net Pyramid DINO 2.....	179	with swivel rotating effect	207
Rope Net Pyramid DINO 3.....	180	Swing Bearing reinforced version	206
Rope Net Pyramid DINO Mini	181	Swing Bearing with swivel	
Rope Net Pyramid DINO XXL	177	made of VA (ball bearings)	207
Rope Net Tower 1	175	Swing Frame "Twin", douglas fir.....	142
Rope Net Tower 2	176	Swing Frame douglas fir	144
Rope Recliner (Inclusive).....	8	Swing Frame douglas fir, long	145
Rubber Edging Cord.....	220	Swing Frame Orlando	7
Rubber Hammock "Dillenburg"	119	Swing Frame Orlando	7
Rubber Hammock "Haiger"	118	Swing Seats "Haiger"	118
Rubber Jumper.....	79	Swinging Honeycomb Nest	37
Rubber Walkway.....	137	Swings	153-155
S		T	
Safety Bearing with chain		Tarantula.....	41
for Bird's Nest swing.....	205	Tension Belt	218
Sandpit Cover	220	Tent Net	73
"Saturn" Trampoline	196	The Look Out	53
Serpent - The Snake	93	Tightrope	64
Shackel rotating swivel M8.....	207	Tipi.....	94
Simple Net Bridge per running metre.....	136	Tower Bridge.....	72
Slackbar	65	Tower Carousel, spinning.....	95
Slackmaster.....	67	Trampoline 2000 – The Original.....	198
Slackmaster Combination 1	68	Trampoline 2012.....	199
Slackmaster Combination 2	69	Trampoline 2014.....	200
Slip-on Sleeve (stainless steel)	218	Trampoline 2017.....	201
Slowworm Midi.....	63	Triops-Pyramid Mini	166
Small Disc "Haiger"	119	Triple Course with slide.....	30
		U	
		Universal Joint for Bird's Nest swing.....	205
		Universal Joint incl. safety bearing	
		for Bird's Nest swing.....	205
		V	
		Vario-Element 1-9.....	120
		Vario-Element 10 -20.....	121
		Victory Swinger.....	110
		Viking Swinger.....	108
		Volleyball Net "Hercules-Clips-Net"	216
		Volleyball Net in "Dralo"	216
		W	
		Witch's Coven Version 1	71
		Witch's Slide & Net	27
		Wobble Beam "Dillenburg"	119
		Wobble Beam "Haiger"	118
		"Wobble Disc" Adventure Bridge	20
		"Wobble Rung" Adventure Bridge.....	34
		"Wooden Catwalk" Adventure Bridge.....	33
		Wooden Walkway per running metre	137
		X	
		X-Pyramid Maxi	184
		XXL Rest Hammocks	162
		XXL-Hammock for Arch Steel Frame	160



HUCK International

Belgium

HUCK N.V.
Atlasstraat 2
B-8680 Koekelare
☎ +32 51 58 23 20
✉ info.sales@huck.be
www.huck.be

Netherlands

HUCK Torimex BV
Kalkbranderstraat 5
2222BH Katwijk aan Zee
☎ +31 71 409 77-00
☎ +31 71 409 77-01
✉ sales@huck-torimex.com
www.huck.nl

Germany

HUCK Seiltechnik GmbH
Dillerberg 3
D-35614 Aßlar-Berghausen
☎ +49 6443 8311-0
☎ +49 6443 8311-79
✉ seiltechnik@huck.net
www.huck-seiltechnik.de

Sweden

ScanCord AB
Svetsaregatan 11
242 35 Hörby
☎ +46 415 15 400
✉ info@scancord.net
www.scancord.net

USA

NetPlay USA LLC
226 Upton Road
Colchester, CT 06415
☎ +1 860 531 2391
☎ +1 860 537 7393
✉ sales@netplayusa.com
www.netplayusa.com

United Kingdom

HUCK Nets Ltd.
Gore Cross Business Park,
Corbin Way, Bradpole Bridport
DT6 3 UX, Dorset
☎ +44 1308 425 100
☎ +44 1308 458 109
✉ hello@huckplay.co.uk
www.huckplay.co.uk

Spain

HUCK SPAIN
Calle Alfonso Solans Serrano 18, Local 8.
50014 Zaragoza
Spain
☎ +34 976 310 826
✉ info@huck-spain.net
www.huck-spain.net

France

HUCK Occitania S.A.
Les Clauzolles
F-81470 Maurens Scopont
☎ +33 563 82 51-31
☎ +33 563 82 51-36
✉ contact@huck-occitania.fr
www.huck-occitania.fr

Czech Republic

Berger-HUCK s.r.o.
Vanišova 552
533 74 Horní Jelení
☎ +420 466 673-306
☎ +420 466 673-305
✉ info@berger-huck.cz
www.berger-huck.cz

Austria

Berger GmbH
Industriestrasse 9
A-2000 Stockerau
☎ +43 22 66 62 126
☎ +43 22 66 62 126-27
✉ sales.at@huck.at
www.huck.at

New Zealand

Playground Centre New Zealand
PO Box 14
Wanganui 4540
☎ +64 6 348 9054
☎ +64 6 348 9355
✉ sales@playgroundcentre.co.nz
www.playgroundcentre.com

Poland

HUCK Polska Sp. z o.o.
ul. Macieja Przybyły 1
54-512 Wrocław
☎ +48 71 325 75 40
✉ biuro@huck.pl
www.huck.pl

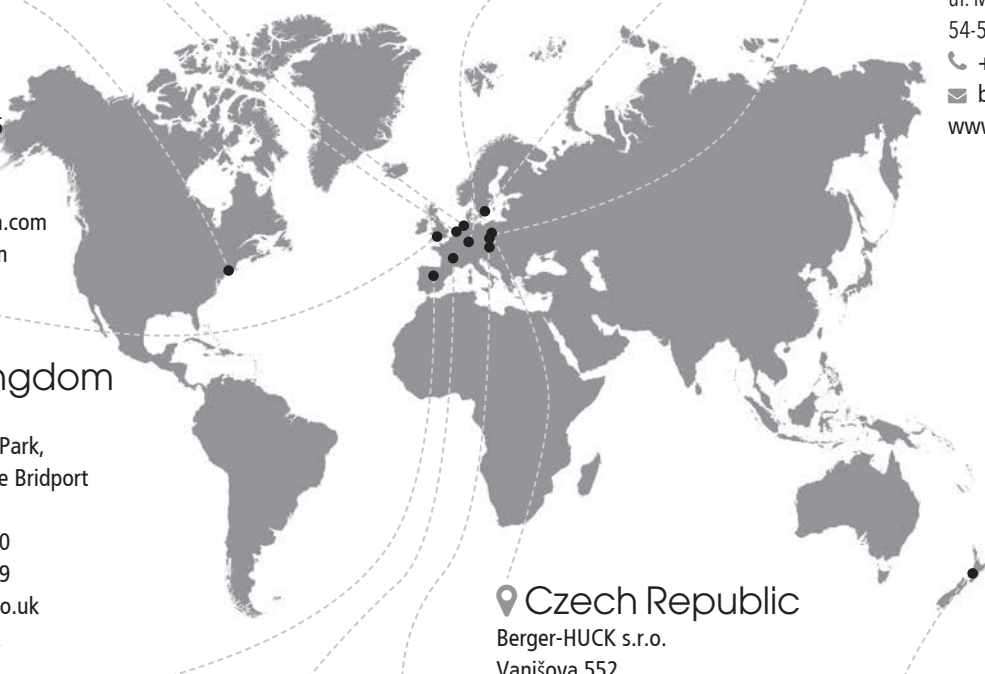



COLOUR CHOICES

Our playground equipment can be ordered in different colour variations of the ropes or plastic connectors at no extra charge.

HERCULES ROPE

Quality in a choice of colours suitable for children



Black 06

Fluorescent Orange 03F*

Hemp 08

Light Grey 66

Red 07

Pink 71

Blue 04

Yellow 05

Green 01

Turquoise 11

Rust 03

*Suitable for Indoor Use

HUCK KNOT BALLS

Perfect for maintenance

By using our HUCK knot balls, individual ropes can be easily replaced at a later date without having to replace the entire net.

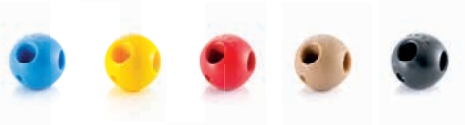

Info

The respective 3D sketches give the rope colours and fixtures and fittings for the equipment.

The photos may show special versions in design and colour.



Symbol Explanations



EQUIPMENT HEIGHT

This measurement gives the highest level of the equipment in its installed state.



SPACE REQUIREMENT

The maximum dimensions of the equipment – incl. the outer edge of the foundation (if these should exceed the minimum space) – is considered to be the space requirement.



FALL PROTECTION AREA

The exact m² required in fall protection material, which must be laid out, e.g. use of liquid fall protection.



MINIMUM SPACE

Space needed for the safe use of the equipment including the falling area, the open space and the space requirement.



DROP HEIGHT

Measurement which has been calculated for the equipment as free drop height, in order to determine the corresponding fall protection covering.



CONCRETE REQUIRED

The roughly calculated amount of concrete needed for the installation of the play equipment³ – Subject to change depending on situation locally.



NUMBER OF USERS

The determined number of possible allowed users on the play equipment.



DIG-IN GROUND ANCHOR

Equipment installed using ground anchors are ready to be played on within the shortest amount of time, since there is no need to wait for the concrete to set.



ACCESSIBLE

For this equipment we have placed value on utilisation in the inclusion area. Consequently, users with disabilities can enjoy unlimited and accessible play fun.



TÜV TESTED AND CERTIFIED

The TÜV mark confirms our play equipment is tested and certified according to European play equipment norm DIN EN 1176.



IPEMA-TESTED AND CERTIFIED

As member of the International Play Equipment Manufacturers Association (IPEMA) we distribute/offer certified equipment. Check product certification visit www.ipema.org.

General terms and conditions of business

Sale and delivery terms and conditions

- Valid as of 01.08.2021

The following conditions form a significant part of the sales contract. They shall be deemed to be accepted by the buyer when an order is placed. Deviating conditions of the customer are then non-binding for us too, even if we do not expressly object to them.

Offers

All offers made on the basis of this list are without engagement, non-binding and shall not obligate us to accept an order. Offers made by telephone need to be confirmed in writing. In case of doubt, the written confirmation shall be valid.

We reserve the right to make technical alterations that serve the further development of our products and that are acceptable to the buyer.

Order units

We have the right to change differing order quantities to the next higher packing unit without enquiring. The exchange or return of custom-made products shall be precluded insofar as these are not defective.

Pricing, packaging

All prices are net and exclusive of the current statutory VAT. With the publication of this catalogue, all previous price lists shall be null and void! Upon publication of this catalogue, all previous price lists shall be null and void.

Our prices are non-binding to the extent that significant changes in raw-material prices and wages may occur after the publication of this catalogue and therefore the calculation bases may no longer apply. Should there be more than four months between the conclusion of the contract and the agreed delivery date, and unless otherwise agreed at the conclusion of the contract, our prices at the time of delivery or preparation shall apply. We reserve the right to pass on the additional costs of raw materials in case of price increases in that area (steel, plastic, etc.) after completion of our catalogue. As a result, article prices may in some cases change correspondingly. Prices shall be valid for at least 1 year after the release of a catalogue, or until a new price list is published. Our prices are quoted "ex works", including packaging. International payment transactions through irrevocable letter of credit.

Payment terms

10 days after invoice date 2% discount, 30 days after invoice date net. In case of late payment interest charged at 1% from the 31st day after date

of invoice. Deliveries to companies not known to us are made cash on delivery or against prepayment. If court action and out-of-court collection costs becomes necessary due to payment arrears we are entitled to charge the debtor. Minimum orders below 25.00 excluding VAT calls for an administration surcharge of ` 4.00 net. Deliveries with an invoice amount below ` 50.00 are entitled to a discount.

Liabilities/complaints

Our liability shall extend to sound handmade production, use of adequate materials and stable and durable construction. You shall notify us immediately of any deficiencies discovered, at the latest within three days of receipt of the goods or of discovery of the deficiency, should this only appear later, inasmuch as the buyer is a trader. Otherwise the goods shall be presumed to be approved. To the extent that no consumer sale has been made, we shall repair or replace free of cost at your option. Should a consumer sale have taken place, the buyer shall be able, in case of a justified complaint, to demand a repair or replacement at his option. Entitlement to a cancellation or reduction and/or to compensation shall only be given if according to our decision repairs cannot be carried out, are not possible or are unreasonable or a replacement cannot be made or the deadline for the same is not observed or an adequate extension given to us is not observed through our own fault. Should the repair or replacement finally fail, the buyer shall be able to demand a reduction in the fee or at his option the cancellation of the contract and/ or compensation.

Warranty

The statutory provisions apply.

Guarantee

For Douglas fir posts where post shoes are used, we shall assume a guarantee of 10 years. For hot-dip galvanised steel posts, a guarantee of 15 years against rust penetration. Three years' guarantee for wooden posts in case of direct installation! For all other pieces (with the exception of wear and tear parts), we shall give a guarantee of 5 years against breakage and material defects. Our guarantee shall be assumed to the extent described under the liability clause. The guarantee shall not extend to parts that are subject to rapid wear (wear and tear parts). The buyer's statutory warranty rights are not affected by this. Damage attributable to wilful destruction (vandalism), incorrect installation, inadequate maintenance or natural wear and tear shall be exempt from the guarantee. Our installation and maintenance instructions must be followed.

Delivery schedule

Delivery times specified by the buyer and their receipt do not constitute a promise of delivery. No compensation claim can be derived from a breach of delivery times. Force majeure and strikes either on our premises or on those of our preliminary suppliers shall release us from delivery obligations. If delivery is not possible, in the presence of the conditions described above, the term of delivery shall be extended.

Retention of title

Para 449 BGB (German Civil Code) forms the basis of all sales. All goods delivered by us remain in our ownership until payment in full of the current account receivables has been made. If the goods are sold on then the due purchase price is deemed to be assigned to us instead. Garnishment and any other adverse effect on our right of ownership must be reported.

Place of fulfilment

Place of fulfilment for deliveries and payment is Aßlar-Berghausen. The district court of Wetzlar/ Regional court of Limburg are deemed to be agreed as place of jurisdiction, for both parts for the placement and acceptance of orders, provided that the buyer is a registered tradesman, a tradesman by law, a legal person under public law or a legal entity under public law. German law shall apply to the exclusion of the Convention on the Sale of International Goods.

Other agreements

Should individual provisions of the sales and delivery provisions be or become invalid in whole or in part, then the validity of the remaining provisions shall not be affected as a result. Deliveries are respectively made "ex works". The loading and the necessary resources and staff must be organised by the customer. Upon request we are able to offer unloading separately for a surcharge.

Our Sombrero swing gives people with disabilities a completely new and communal swinging experience – and in the safest way possible. In the middle of the sombrero there is an elevation that allows the users of the playground equipment not only to lie, squat or stand, but also to sit safely and lean back with a firm hold.

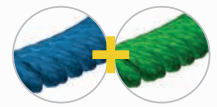

New two-tone combination of rope wrapping!

Original HUCK Bird's Nest Sombrero

Art.-No. 4649-140 / Art.-No. 4649-120

HUCK Seiltechnik GmbH

Dillerberg 3
D-35614 ABlar-Berghausen
Zentrale +49 6443 8311-0
seiltechnik@huck.net
www.huck-spielgeraete.de

Management

Valentin Huck
Stefan Huck
Wolfgang Keiner

Sales

Ria Gaidartzi	+49 6443 8311-63 ria.gaidartzi@huck.net
Roman Gerth	+49 6443 8311-61 roman.gerth@huck.net
Nadja Jakob	+49 6443 8311-97 nadja.jakob@huck.net
Sven Käbisch	+49 6443 8311-71 sven.kaebisch@huck.net
Jasmin Küster	+49 6443 8311-55 jasmin.kuester@huck.net
Ingo Lepper	+49 6443 8311-76 ingo.lepper@huck.net
Luisa Martin	+49 6443 8311-72 luisa.martin@huck.net
Andreas Rossmeisl	+49 6443 8311-86 andreas.rossmeisl@huck.net
Ellen Wendel	+49 6443 8311-64 ellen.wendel@huck.net



This printed product was awarded the Blue Angel.



Print product with financial
climate contribution
ClimatePartner.com/53323-2311-1017